

FOTILE

RANGE HOOD

User Manual | EMG9035

Any needs, please contact FOTILE service center.
Some pictures in this manual are sketch map, only
for reference. If there are some discrepancies,
please subject to real object.

WWW.FOTILEGLOBAL.COM

Please read carefully about the user manual before using the product.
And keep it well after reading, for future reference.

CONTENTS

Warning and Safety Instructions	1
---------------------------------------	---

Usage	4
Main Technical Specifications	4
Operation Instruction	5

Cleaning and Maintenance	6
--------------------------------	---

Normal Malfunction and Trouble Shooting	8
---	---

Installation	9
Fume Collection Rangs	9
Packing List	10
Installation Methods	11
Product Basic Conditions	12
Installation Suggestions	12
Installation Steps	14
Debugging	15
Component Name Diagram	16

Dear User, thank you for purchasing the Fotile Range Hood. At Fotile, we manufacture exquisite appliances that are expertly crafted with the finest materials. Before using the Fotile Range Hood, please take some time to read through this Product Manual (manual). It will familiarize you with important safety, operation and maintenance instructions, as well as help maximize your culinary experience.

Before using the Fotile Range Hood, you must follow the instructions, as specified in this manual. Any damage resulting from the improper operation and/or maintenance of the appliance may result in the loss of warranty. The warranty will become invalid, and your warranty application, whether direct or indirect, will not be accepted by authorized service center of Fotile. If you require warranty or post-warranty after-sale service, please contact the local authorized service center of Fotile nearest you.

Your satisfaction with the Fotile brand is important to us. Our after-sales service centers provide assistance in resolving issues with Fotile appliances.

Product model and serial number are required if you need services.

Product features and specifications are subject to change, at any time, without notice and may be different from those in this material. Please visit our website at www.fotileglobal.com for the most up-to-date information.

Warning and Safety Instructions

Special version:

Please properly use the appliance, strictly complying with the user manual. FOTILE company will not bear responsibility for property loss and personal injury due to improper use.

Warning:

This appliance is not intended for use by persons (including children) with reduced physical, sensory or mental capabilities, or lack of experience and knowledge, unless they have been given supervision or instruction concerning use of the appliance by a person responsible for their safety.

The appliance can be used by children aged from 8 years and above and persons with reduced physical, sensory or mental capabilities or lack of experience and knowledge if they have been given supervision or instruction concerning use of the appliance in safe way and understand the hazards involved (only for EU market).

Children shall not play with appliance.





Cleaning and user maintenance shall not be made by children without supervision.







CAUTION: Accessible parts may become hot when used with cooking appliances.

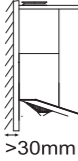

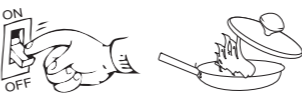
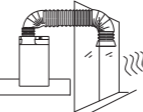
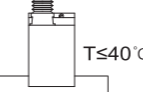

- a. Pour out the gathering oil periodically; please wipe the range hood surface once after every using the range hood.
- b. Please frequently clean the range hood surface and oil cup.
- c. There is a fire risk if cleaning is not carried out in accordance with the instructions.



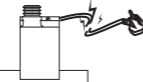





Strictly execute

 Ground Connection	The plug should be connected with reliable ground wire to ensure safety. The ground wire should not be connected with gas pipe, tap water pipe, lightning rod and telephone line. Bad ground connection may cause electric shock or other accidents.
	Because the installation procedure of the range hood is complex, and the weight is heavier, it should be installed by professional person according to the instructions. Failure to install the screws or fixing device in accordance with these instructions may result in electrical hazards.
	If the new range hood is damaged obviously before using, please don't install and contact FOTILE service center soon.
	Please comply with the safety guideline provided by the heating equipment manufacturer priorly and safety regulations published by the fire authority simultaneously.
 >30mm	The wall should be strong enough to support the range hood. As for hollow wall or hollow plate, the thickness of its solid part should be no less than 30mm. For drywalls, the range hood shall be fixed onto the wooden pillar at the back, mounting holes can be drilled directly into concrete walls. The range hood should be firmly fixed on the wall.

	When drilling on the roof or ceiling, please make sure not damage the electric wires and any other hidden devices.
	The range hood is for family use only, and don't use it in special environment (e.g. outdoor), and it also can't be used to exhaust dangerous or explosive substance or gas. Fotile assumes no responsibility if you use it in special environment.
	There shall be adequate ventilation of the room when the range hood is used at the same time as appliances burning gas or other fuels (not applicable to appliances that only discharge the air back into the room).
	When the cooking pots catch fire, turn off the range hood immediately (It will stimulate the fire if the range hood is working). Effective fire extinguishing measures must be taken at once, such as covering the open flame with metal cover, turning off the general gas valve and keeping flammable substance away from the open flame, etc.
	Make sure the exhausting pipe can reach outdoors to avoid the fire and keep the fresh air in the room. Please don't make the waste gas stay indoor, loft, garage, etc. (This is only for ducted range hood)
 $T \leq 40^{\circ}\text{C}$	The working temperature should not be more than 40°C .
	Please clean the range hood according to the user manual, otherwise, it may catch fire or cause other dangers.
	Please clean the oil cup timely to avoid overflowing when the oil reaches the very scale in the oil cup. Please don't use the waste oil.
	Before install, clean or repair the range hood, please make sure cut off the power to avoid the electric shock. And wear protective gloves to avoid your hands being hurt by range hood metal panel.
	The plug shall be accessible after the appliance has been installed. Cut off the power if you are not going to use range hood for a long time.
	If the supply cord is damaged, it must be replaced by the manufacturer, its service agent or similarly persons in order to avoid a hazard.

	<p>If there is abnormality, please turn off the range hood and cut off the main power supply, contact FOTILE service center to repair it. It will easily cause dangers like electric shock, fire, if the range hood still working under abnormal conditions.</p>
	<p>Please don't let children use range hood by themselves and don't place it where infants can touch, otherwise, it will cause burning injury, electric shock or other accidents.</p>
	<p>Please keep the product plastic package away from the infants, to avoid suffocation, etc. Children should be supervised to ensure that they do not play with the appliance.</p>

Forbidden

	<p>Please clean the range hood according to the user manual, otherwise, it may catch fire or cause other dangers.</p>
	<p>Don't transform, stretch, tie, ballast or extrude the power cord, or it may cause electric shock or fire.</p>
	<p>Don't change the internal wiring by yourself, otherwise, it will cause possible abnormality and personal injury; and the improper repair leads to electric shock, fire or other dangers.</p>
	<p>The air must not be discharged into a flue that is used for exhausting fumes from appliances burning gas or other fuels.Regulations concerning on the discharge of air have to be fulfilled.</p>
	<p>It is strictly forbidden to let the stove working without pot otherwise it will damage the above range hood.Do not flame under the range hood.</p>
	<p>Don't touch the bulb that is still working or finish working for a short while, to avoid scalding.</p>
	<p>Don't put your hands or other things into impeller when it is working to avoid hurting.</p>
	<p>All electrical parts including motor, switch and connections, etc. should be away from water. Don't rinse range hood directly with water. Don't use the range hood when it is wet to prevent electric shock.</p>
	<p>Never touch the power plug, power switch or other electric parts with wet hand, otherwise, it may cause electric shock.</p>



- a. Services guaranteed under warranty must be performed by Fotile certified service provider or personnel. The warranty is not effective for products removed for repair without authorization.
- b. Adhere to the voltage and frequency settings listed in this manual to avoid possible damages to the range hood.
- c. When the range hood and appliances supplied with enegy other than electricity are simultaneously in operation, the negative pressure in the room must not exceed 4 Pa(4 x 10⁻⁵ bar) (only for GERMANY).
- d. Range hoods and other cooking fume extractors may adversely affect the safe operation of appliances burning gas or other fuels (including those in other rooms) due to back flow of combustion gases. These gases can potentially result in carbon monoxide poisoning. After installation of a range hood or other cooking fume extractor, the operation of flued gas appliances should be tested by a competent person to ensure that back flow of combustion gases does not occur.
- e. Tempered glass is applied to the products of the company and the tempering treatment of the glass determines the extremely little possibility of spontaneous explosion.If the occurrence of spontaneous explosion is not due to improper use, our company promises free replacement of the accessories.The possibility of tempered glass breaking can be significantly increased in the following situations, which should be avoided: For instance, hitting the glass, especially the corners of the glass, with cooking utensils or other hard objects; The glass is impacted when you open a cabinet door around the Range Hood; Put the glass in an extremely hot or cold environment or an environment where heat and cold are excessively alternated.

Usage

Main Technical Specifications

Electrical parameter

Model	Voltage/Frequency	Input Power	Motor Power	LED Light Power
EMG9035	220~240V/50Hz	260W	258W	2W

Exhaust model (exhaust pipe)

Model	EMG9035	Product size	895mm(L)×512mm(W)×582mm(H)		
			Gear	Auto Turbo speed	High speed
220V/50Hz	Air flow(m ³ /h)	1030	900	700	
	Noise(dB(A))	54	48	42	
	Max static pressure(Pa)	880	870	500	
240V/50Hz	Air flow(m ³ /h)	1030	900	700	
	Noise(dB(A))	55	48	42	
	Max static pressure(Pa)	1050	910	490	



- a. This product is intelligent. When the exhaust resistance of the product is greater than the set resistance, the maximum air volume in automatic cruise pressurized mode can be up to 1420m³/h in 220V/50Hz and up to 1440m³/h in 240V/50Hz.
- b. Noise shown in table is sound pressure level. Weighted sound power level noise is the sound pressure level noise plus 14 dB.
- c. The air flow in the table are tested in accordance with IEC 61591-2010 standard. The noise in the table are tested in accordance with 60704-3-2006 standard.

Operation Instruction

Let's be familiar with the range hood control interface.

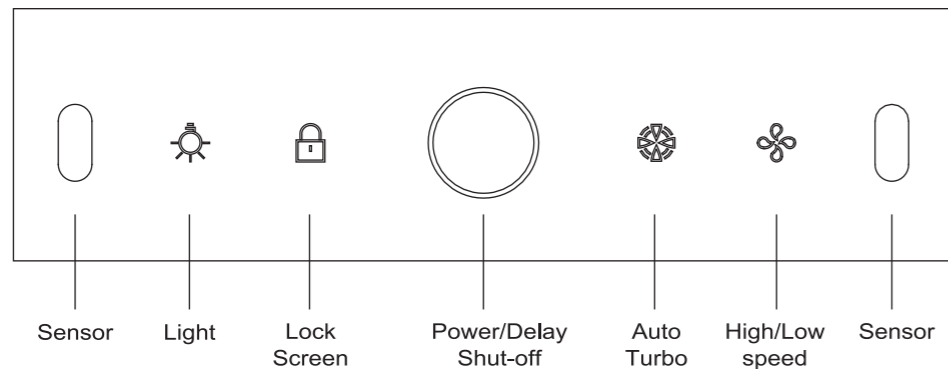

1. Power/Delay button ○

- (1) Press the button ○ once and the button ○ stays on, then the range hood is turned on while turns off when no other key operation is made within 2 minutes;
- (2) When the fan is on, press the button ○ once and the button ○ flashes, then the range hood goes into the delay state and turns off when no other operation is made within 2 minutes.
- (3) When under the delay state, press the button ⚙️ / 🔒 to stay at the delay state.
- (4) When under the delay state, press the button 🌀 / 🌀 to exit the delay state and navigate to corresponding functions.
- (5) When under the delay state, press the button ○ to turn off the range hood.
- (6) When under the delay or standby state, press and hold the button ○ for 5 seconds to turn off all functions (including gesture sensing) and the range hood turns to off state. Press the button ○ again, the feature of gesture sensing recovers automatically.

The following commands shall be given under the standby state.

2. Auto button 🌀

Press the button 🌀 again and the button stays 🌀 on, then the range hood operates in auto turbo mode (in this mode, the flue resistance can be automatically detected, and the range hood can be adjusted for different operating states based on the flue resistance). Press the button 🌀 again, the fan turns off.

3. High/low button 🌀

- (1) Press the button 🌀 once and the button 🌀 stays on, then the range hood operates in high speed.

- (2) Press the button 🌀 again in high speed state and the button 🌀 becomes dimmer, then the range hood operates in low speed.
- (3) Press the button 🌀 again in low speed state and the fan turns off.

4. LED lamp button 🌀

Press the button 🌀 once and the button 🌀 stays on, the LED lamp turns on. Press it again, the LED lamp turns off.

5. Screen lock button 🔒

- (1) Press and hold the button 🔒 for 1.5s and the button 🔒 stays on, then the range hood steps in screen lock when any other keys (including the gesture sensing feature) are operated, the button 🔒 flashes and beeps, prompting that the key does not work.
- (2) Press and hold the button 🔒 for 1.5s to remove the screen lock and all keys can be operated soundly.

6. Gesture sensing

- (1) Wave your hand 🖐️ to quickly pass through the induction windows at both ends to turn on/off the range hood (including the fan & LED lamp).
- (2) When the range hood is off, press buttons 🖐️ and 🖐️ together for 5s to turn on/off the gesture sensing feature.

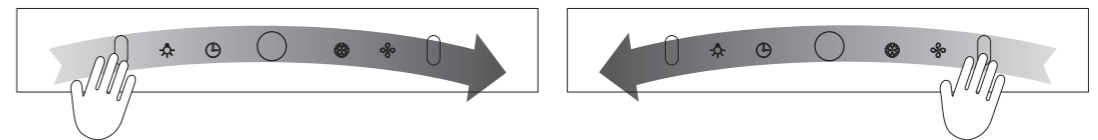

Schematic diagram of gesture sensing feature

Cleaning and Maintenance

- Warning:** • The range hood may be at risk of fire if it is not cleaned as specified in the Instruction.
- Before the range hood is cleaned or repaired, it should be made sure that the power cord is unplugged to avoid electric shock.
 - While the range hood is being cleaned, water should be prevented from entering electrical components such as motors and control keys
 - When the fan is in operation, it is forbidden to put your hand within the operating area of the fan.
 - Gasoline, acids, benzene, solvents or any other chemicals shall never be used to clean the range hood.

In order to use the range hood more comfortably, the surface of the range hood, Ring suction plate, air intake hood and oil cup should be frequently cleaned.

Cleaning the surface of the range hood, Ring suction plate, air intake hood and oil cup frequently will facilitate the normal use of it.

Cleaning the surface of the range hood

Warning: In order to avoid scratching the surface of the range hood, never clean the machine with rough objects such as cleaning balls, brushes, scouring pad and coarse cloth.

- 1. The range hood shall only be cleaned with neutral soap or detergent. After cleaning, dry the surface with a soft cloth.

2. If the surface of the range hood appears to be smeared, a neutral detergent shall be used to clean the stain and the detergent shall not touch the control keys. Drip the detergent to the stain and leave it on the stain for a moment (the detergent should not stay on the range hood for too long, otherwise damage will be caused to the range hood). Wipe off the stain using a soft rag; remove the detergent with a slightly damp towel, and then dry the body with a soft dry towel.
3. Do not leave stains on the surface of the range hood for too long.
4. If you accidentally drip salt solution, disinfectant, bleach and other detergents on the stainless steel panel(most of these detergents contain harmful chemical ingredients), immediately wipe it with damp cloth and then dry it with dry cloth.

■ Cleaning oil cup and wing plate

1. Hold both ends of the oil cup with both hands, keep the oil cup horizontal, move out slowly toward the front direction of the range hood, take down the oil cup and then drain off the accumulated oil (Figure 1);
 2. First, grasp the front edge of the wing plate with both hands, turn it down to disengage the wing plate locking tab, and then turn it down at a certain angle to take down the wing plate (Figure 2), soak the oil cup & wing plate in warm water containing neutral detergent and clean them with a soft brush;
 3. After cleaning, dry it before installing the wing plate and oil cup.
- ★ Advice: After each operation of the range hood, please wipe the outer surface of the range hood (including the outer surface of the wing plate); Clean the wing plate every three months.

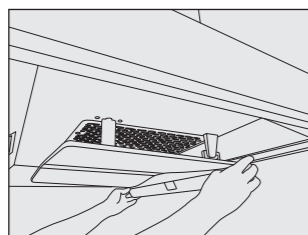

(Fig1)

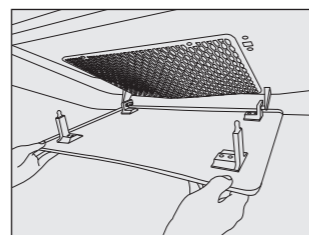

(Fig2)

■ Replacing LED lamp

1. Hold the LED lamp with left hand, insert the small straight screwdriver into the edge of the LED lamp with right hand (Figure 3), pry downwards with slight force, take down the LED lamp, and then open the wire socket (Figure 4);
2. Replace the entire LED lamp;
3. Buckle the LED lamp into the lamp hole with both hands.

⚠ Warning: The LED lamp shall only be replaced by professionals, and the power plug must be unplugged before the replacement.

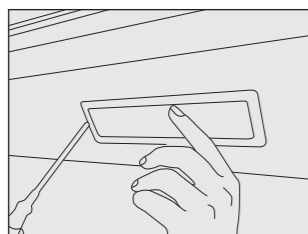

(Fig3)

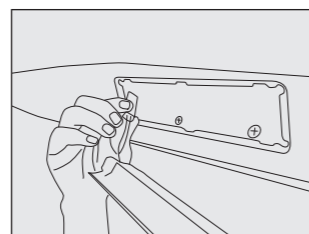

(Fig4)

Normal Malfunction and Trouble Shooting

In case of any abnormal condition discovered while the range hood is running, please stop using it, unplug the power plug and make the following checks:

Malfunctions	Possible reasons	How to check
Range hood can't work, light can't lighten	Haven't connected with power supply	Check whether the plug is well inserted or not
		Check whether there is electricity or not in the plug
Motor can working, but light can't lighten	LED light is damaged	Replace LED light (done by professional people)
There is machinery shaking noise	Screw is loosed	Check whether the surface screws are tightened or not
Suction power is weak	Too long distance between range hood and stove	Lower the range hood installation height (done by professional people)
	Too much ventilation near the range hood leads to strong convection	Close some doors and windows
	Exhaust duct has not been cleaned for long time	Replace the exhaust duct
	The check valve is stuck (not opened completely)	Clean or replace the outlet housing
Noisy	Exhaust pipe surface is distorted	Reinstall exhaust pipe (done by professional people)



- a. Change the LED light: please contact FOTILE after-sale service center.
- b. If the range hood still can't work after getting rid of the above malfunctions, please contact FOTILE service center.
- c. The following information is required for the warranty period:
 1. Date of purchase
 2. Product model
 3. Serial number
 4. Relevant vouchers for purchase
- d. The ventilator shall be not allowed to be repaired by any party other than Fotile's appointed technicians. Otherwise it may cause serious consequences and exempt the product from warranty.
- e. The following circumstances do not fall into the scope of free warranty, and a fee will be charged for repair.
 1. Damage resulting from improper handling, installation, use, maintenance and safekeeping conducted by customer.



- 2.Failure and damage caused by using the product beyond the normal operating conditions(damage caused in the case that the voltage is higher than 264V or lower than 189.2V).
- 3.The product installed, dismantled or repaired by customer or any party other than Fotile's appointed service staff or agency.
- 4.Discrepancy between the information on the purchase voucher and the warranty card and the product.
- 5.Product damage caused by force majeure (such as natural disaster and war, etc.).
- 6.Product failure or damage arising from use not in conformity with the "instructions".

Installation

Fume Collection Range

Left and right fume collection range of the range hood

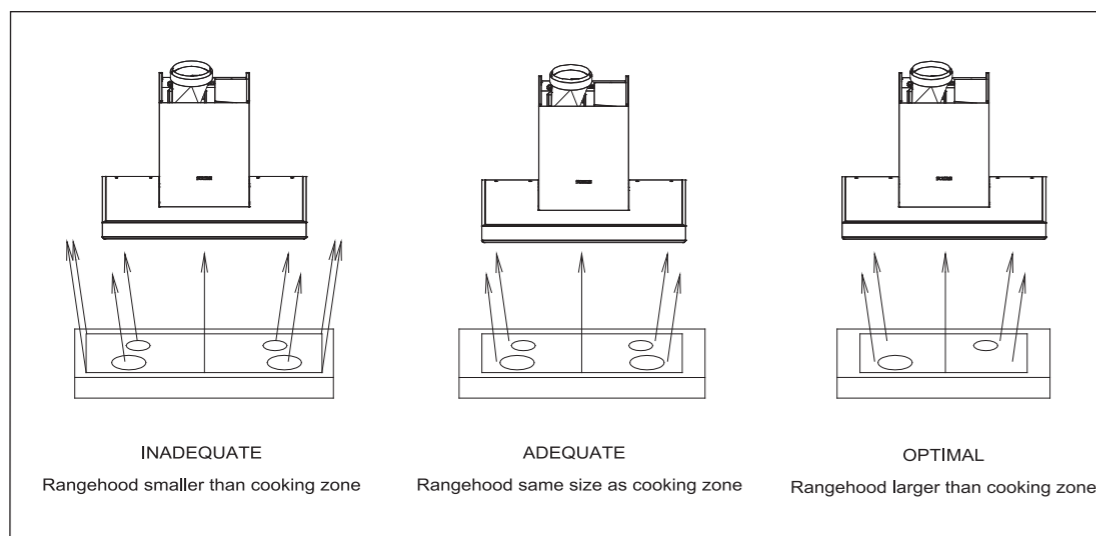



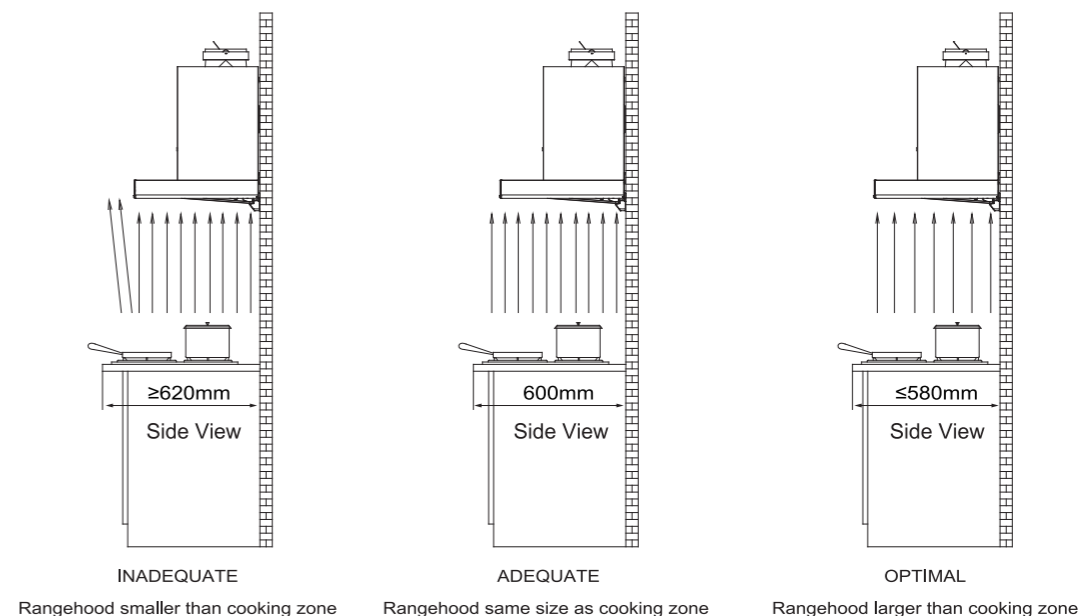

Front and rear fume collection range of the range hood



Packing List

	Complete Appliance	1		Ring suction plate assembly	1
	Exhaust Pipe	1		Exhaust Cover	1
	Aluminum Foil Tape	1		Upper Seal Mat	1
	Decorative Cover	1		Pothook	1
	Decorative Cover Pothook	1		Oil Cup	1
	User Manual	1		Screws ST3.9x9.5	4

	Expansion Pipe φ 10x60	6		Wooden Screws 4.5x60	6
	Duct Cover Screws M4x18	8		Screws ST2.9x19	4
	Screws M4x6	2			

Installation Methods

■ **Safety precautions**

★ **Special note: for safety and proper operation, the installation and maintenance of the product (incl.the exhaust duct and other parts) shall be done by designated qualified professional. If the product stops work due to installation or maintenance by the customer or any third party entrusted by the customer, the free maintenance and repair service will not be available, even it is within the warranty period.**

Please read the instructions carefully before installing the product and note that:

1. If you are renovating your kitchen, do not expose the range hood. Construction materials, dust, paint,coating, and the evaporated gas may corrode and fade the surface of the hood. It is recommended to install the range hood after decoration of the kitchen.
2. Since the installation of the range hood is complex and the hood is heavy, it shall be done by qualified installation & maintenance professionals in accordance with the Instruction.
3. The range hood may be designed with sharp edges, so please wear protective gloves during installation,cleaning or maintenance.
4. When drilling the wall, do not damage the electric wires or other hidden devices. Do not power on the range hood and disconnect the power in the main power box during installation.
5. Exclusive grounded power outlet is required for the range hood. When the power cord is extended through a multi-port wiring connector and an extension cord, electric shock, heating of plug and socket, and fire are likely to occur. Please make sure that the power cord is extended by a professional electrician in strict accordance with all applicable national and local power regulations; prior to wiring, the power supply should be turned off and reasonable measures should be taken to prevent automatic connection of power.
6. If the gas stove needs to be moved before the range hood is installed, please turn off the main valve of the gas before moving the gas stove.
7. The strength of the wall should be strong enough to install the range hood.
8. In order to ensure safety and smooth installation, please use the attached accessories for installation. The expansion tube shall be installed in a way that avoids forming an over-size hole on the wall, as a way to prevent the fall of the expansion tube.
9. To avoid fire, the exhaust gas should be discharged to the outside.
10. Do not discharge the exhaust gas into the wall, attic or garage.
11. Do not discharge the exhaust gas from the range hood to a flue that is used for exhausting fumes from appliances burning gas or other fuels.

12. When being installed, the range hood should remain horizontal.
13. After installation, the range hood shall be confirmed to be qualified if there is no abnormality during commissioning. Users are advised to read this Installation Instructions carefully and keep it in a proper manner.



Wall Preparation

The wall should be strong enough to support the range hood. As for hollow wall or hollow plate, the minimum thickness of the lumber should be 30mm. As for concrete wall, the installation can be directly operated. The range hood should be firmly fixed on the wall.

Product Basic Conditions

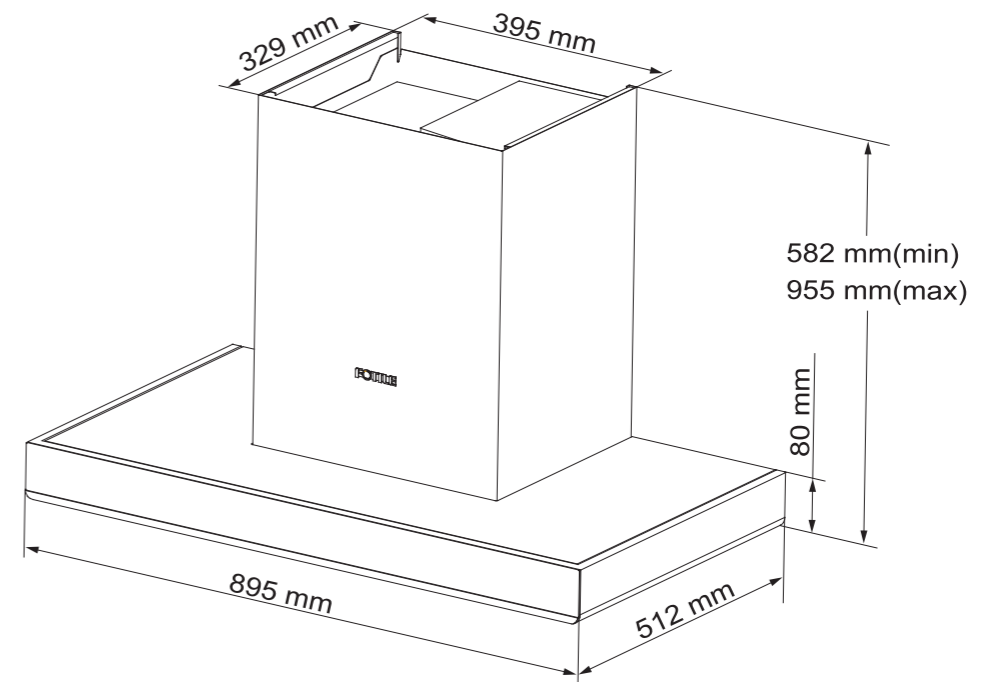

Product Basic Conditions

Installation Suggestions

■ **Installation Position**

other conditions.
blower outer cover bottom end and cabinet bottom end.
The temperature of the range hood should not be more than 40°C .
The wall should be none-flammable. Never install the range hood on the flammable wooden wall.

■ Installation Diagram of Hoods and Cabinets. (Unit: mm)

Hole size of ceiling or cabinet

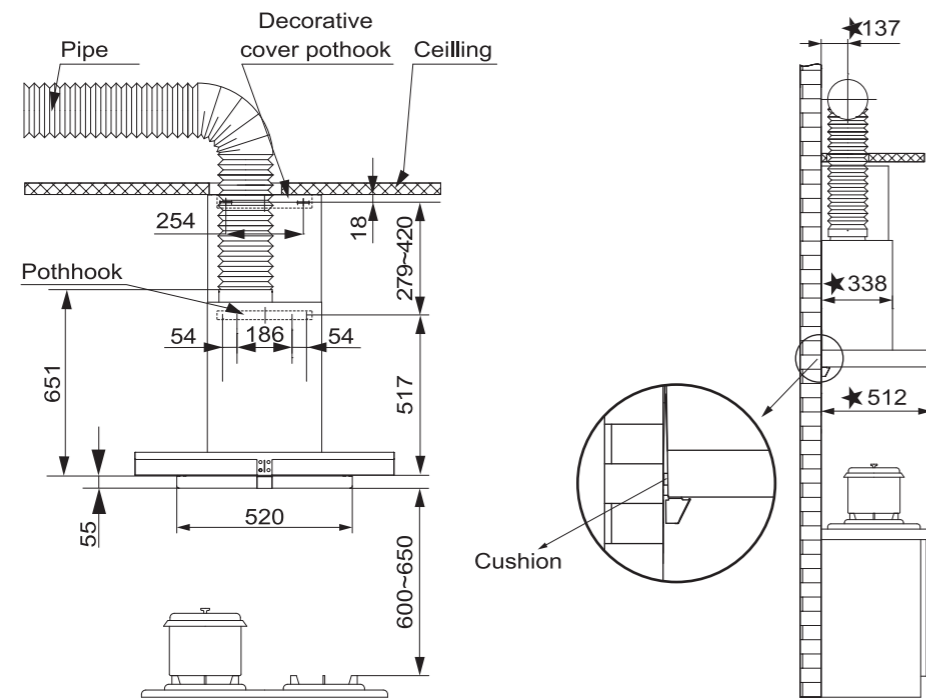
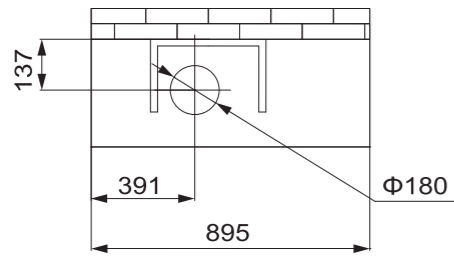

Installation diagram
(★ is the distance from the wall)



The installation height of the range hood is the recommended value, and the cupboard and the range hood shown in the figure is for reference only. When the installation height of this product (i.e. the distance between the supporting surface of the cooking appliance on the range and the lowest part of the range hood) is lower than 600mm, all parts below 600mm are non-flammable parts of the range hood or parts working under safe and ultra-low voltage, and the deformation of these parts will not affect the protection against the touch of live parts. (If relevant laws in the region stipulate the installation height of range hood, it is recommended to abide by relevant laws, but the oil smoke suction effect of the product may be affected to some extent.)

■ Preparation before installation

1. Warning: Please don't make sundries into exhaust pipe to avoid damaging the range hood. Estimate the exhaust pipe position. A straight and short exhaust pipe makes smoke extraction more smooth, please refer to installation diagram. The joint between exhaust pipe and wall hole should be sealed with tape, and ensure firm connection between exhaust pipe and exhaust cover. Too small wall hole will affect smoke extraction, therefore, please broaden the wall hole to fit exhaust pipe size under safety condition.

2. Tool preparation

Please prepare the following tools before range hood installation(include but not limited to the following tools).

- | | |
|---|-----------------------|
| (1) Impact electric drill (with drillbit of Φ 10mm) | (2) Cross screwdriver |
| (3) Cutting pliers | (4) Measuring tape |
| (5) Hammer | (6) Level ruler |

Installation Steps

1. Reserve Φ10mm drill bit for the impact electric drill.
2. Refer to installation diagram, set the right position on the wall to drill and then firmly imbed the expansion pipe. Insert wooden screws to tighten the fixed pothook and decorative cover pothook; then use two ST2.9×19 self-tapping screws to fix the decorative cover on the suspended ceiling (see Fig 1 and Fig 2).
3. Refer to Fig 3, use eight M4×18 screws to fix the exhaust cover and upper seal mat on the top of complete appliance.
4. Use two ST3.9×9.5 self-tapping screws to fix the exhaust pipe on the exhaust cover and seal with aluminum foil tape (see Fig 3).
5. Hang the hood firmly: face squarely-not slanting, side-looking-the hood will tightly stick the wall and a little lacune.
6. Install the exhaust pipe according to installation diagram: check the pipe shell is not bulging and not shriveled, curve freely. The exhaust pipe and wall should be tightly connected to prevent smoke back, the backflow barrier blade should be up and down smoothly.
7. As illustrated in Figure 4, the fan frame is securely connected with the hook by using M4×6 short screw;
8. Blower outer cover and decorative cover installation(see Fig 5)
 - (1) Put the decorative cover inside of the blower outer cover.
 - (2) Take up the blower outer cover and decorative cover meantime; inject the decorative cover into decorative cover pothook, then push the decorative cover and blower outer cover along the decorative cover pothook assembly to the end.
 - (3) After pushing the decorative cover and blower outer cover to the end, the blower outer cover will slip down slowly, and inject the blower outer cover buckle to the blower rack, then insert the blower outer cover to the gap which is between top panel and blower rack.

9. Installation of ring suction plate

- (1) Hold the front side of the ring suction plate firmly with both hands, and place the left and right pothooks on the rear side of ring suction plate into the left and right hook racks of the smoke collecting hood.
- (2) Prop the ring suction plate with both hands, make it spiral upward, push in while the ring suction plate spirals, finally make the touch claw on the ring suction plate insert into the touch button on the smoke collection hood.

10. Insert the host power plug into the power outlet.

11. Install the oil cup (see Fig 6).



- a. Please take down the blower outer cover before installation.
- b. If you install the range hood matching with cabinet, then exchange Step (4) and Step (5).
- c. Please select right drill bit according to the drilling place specific situation.

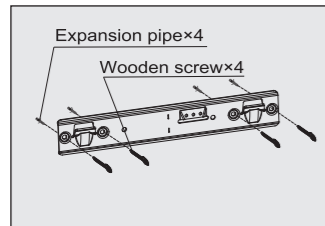

(Fig.1)

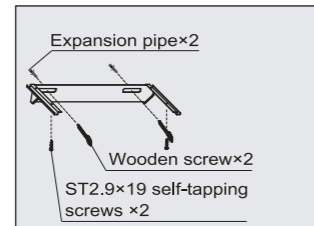

(Fig.2)

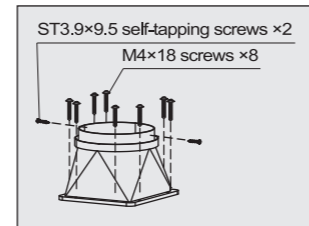

(Fig.3)

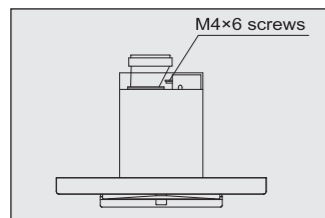

(Fig.4)

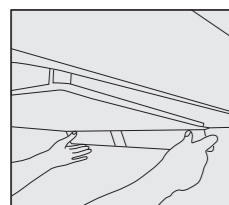

(Fig.6)

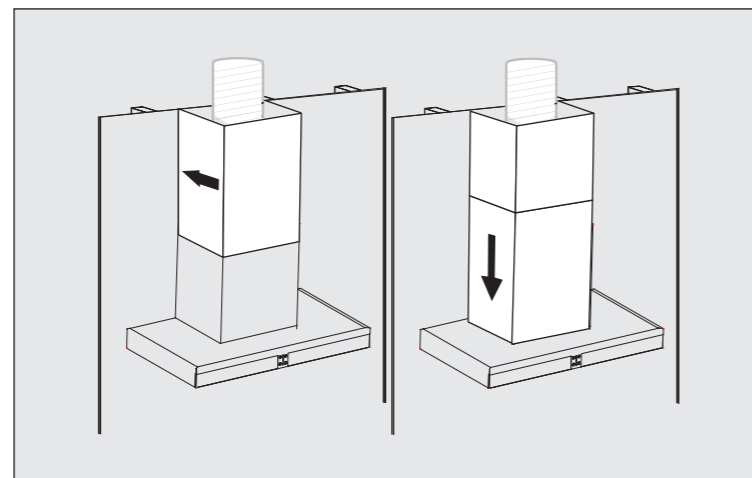

(Fig.5)

Debugging

- 1. Press power key, and press light key, check whether light works normally.
- 2. Press motor key, check whether motor turns normally. In the following cases, cut off power, stop turning and check whether it is reason of installation (if range hood breaks down, please contact our service center).

- (1) Machine shakes violently
- (2) Expansion pipe looses
- (3) Impeller doesn't turn
- (4) Impeller with obvious grating when turning
- (5) Motor with abnormal noise

5. Press power key twice, motor stops turning.

- (1) If the power supply wire is damaged, in consideration of the safety, must have the manufacturer, the repair department or similarly qualified personnel to replace.
- (2) When the range hood, gas stove or other fuel stove used at the same time, the room must be well ventilated.

Correct Disposal of this product



This marking indicates that this product should not be disposed with other household wastes throughout the EU. To prevent possible harm to the environment or human health from uncontrolled waste disposal, recycle it responsibly to promote the sustainable reuse of material resources. To return your used device, please use the return and collection systems or contact the retailer where the product was purchased. They can take this product for environmental safe recycling.

Component Name Diagram

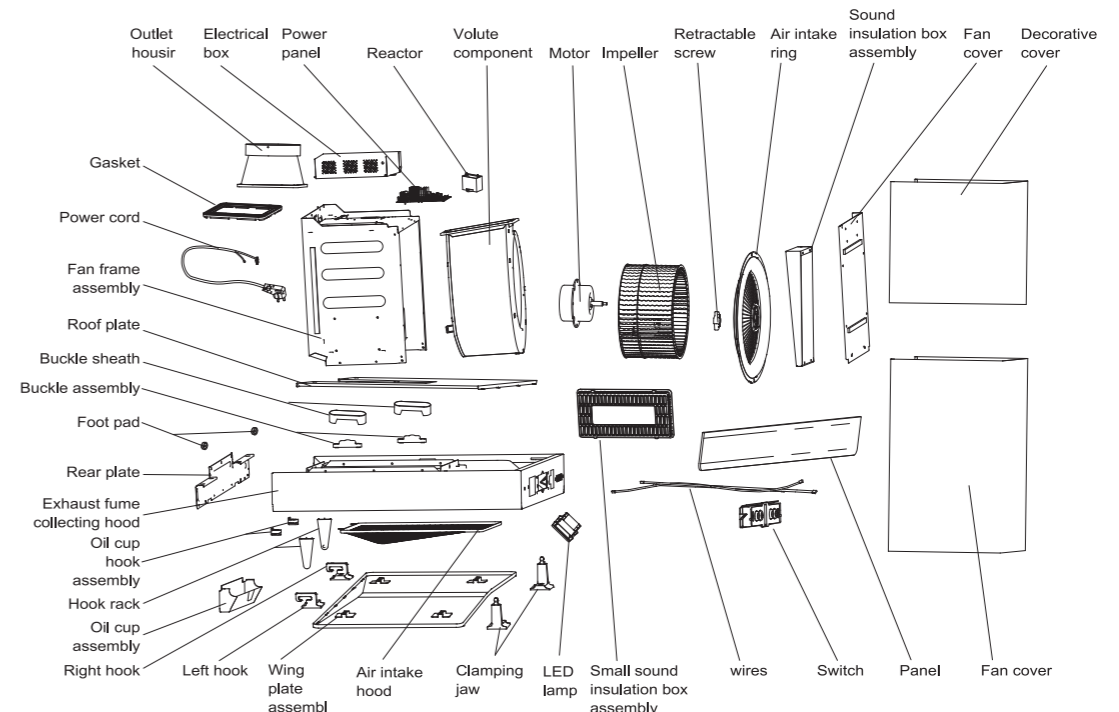

FOTILE

吸油煙機

使用安裝說明書 | EMG9035

請在開始安裝和使用前仔細閱讀此產品說明書。
請保留此產品說明書，以供今后使用或后續用戶使用。

如有任何需要，請聯系方太授權的服務中心。本說明書部分圖片為示意圖，僅供參考，若圖片與實物不符，以實物為準。

WWW.FOTILEGLOBAL.COM

目錄

警告和安全說明	1
使用方法	4
主要技術參數	4
操作說明	5
清潔保養	6
常見故障的識別和處理	7
安裝	8
籠烟範圍	8
裝箱單	9
安裝警告	10
產品尺寸圖	11
安裝建議	11
安裝步驟	13
安裝后的調試	14
爆炸圖	15

產品特征和參數會在無通知情況下隨時更改，并且可能與此說明書略有不同。請訪問我們的官網www.fotileglobal.com，獲取最新信息。

尊敬的用戶，您好！感謝您選購方太公司為您精心制造的方太系列產品，使用前請通讀本《使用安裝說明書》（以下簡稱說明書），此說明書將有利于您熟悉油煙機安全信息、操作和保養維修等，并讓您享受到全新的下廚樂趣。

請您在使用前務必認真閱讀說明書，并遵從說明書要求進行使用。本說明書的操作說明對於維持產品的良好工作狀況十分重要，若因使用不當造成產品故障，您將失去免費保修的權利，任何直接或間接的免費保修申請將不被本公司各地授權的服務中心所接受。同時我們建議您在質量保修期內及保修期后，如有需要維修時請與方太公司當地授權的服務中心聯系，這對您和我們都是非常重要的。

我們授權的服務中心將為您提供方太公司專業的零部件及技術支持，使您的產品得到優質快捷的維修保障，同時讓您得到最輕鬆細心的服務。

如果您需要服務，您將需要提供產品型號和序列號。

警告和安全說明

特別說明：

請嚴格按照本說明書規定使用，由于本產品不當使用造成的任何財產損失、人身損害，本公司不承擔責任。

警告：

此產品不適用於（包括兒童在內）身體、感知或精神能力減弱或缺乏經驗或知識的人群，除非在對其安全負責的人監督或指導如何安全使用此產品的情況下。

此產品不適用於（包括8歲以下兒童）身體、感知或精神能力減弱或缺乏經驗或知識的人群，除非在對其安全負責的人監督或指導如何安全使用此產品的情況下（針對歐盟市場）。

孩童應受監管，確保其不玩弄此產品，且孩童不應私自清潔和維修此產品。











注意：操作中可觸及部分可能會變得很燙。



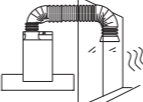

- a. 請定期倒去積油；每次使用吸油煙機后，請擦拭吸油煙機外表面。
- b. 為了更加舒適地使用，請經常對吸油煙機外表面和油杯進行清潔。
- c. 如果不按說明書規定的方法清洗，吸油煙機有起火的危險。

嚴格執行

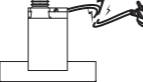
 <p>接地</p>	<p>插頭必須插在合理安裝并接地的電源插座上，以確保安全。接地線不得與煤氣管、自來水管、避雷針、電話綫等連接。接地不良可能會引起觸電或其他事故。</p>
	<p>由于本吸油煙機的安裝程序比較復雜，且重量較重，應由專業安裝維修人員按照說明書進行安裝。未按說明書要求安裝螺釘或固定裝置可能會導致觸電、脫落、起火等危險。</p>
	<p>使用此新產品之前請開封檢查此產品是否受損，如果發現此產品有明顯的損壞，請勿安裝使用，請您立即聯系方太授權的服務中心。</p>
	<p>請遵照加熱設備廠家的安全指南，同時要遵照消防等管理部門頒布的安全標準進行。</p>
 <p>>30mm</p>	<p>安裝吸油煙機的牆壁要有足夠的支撐強度，對於中空牆壁，中空板實心層的厚度必須大于30mm以上，如為石膏板牆壁需固定在其背后的木柱上，對於混凝土牆壁可直接打安裝孔。整機必須牢固安裝在牆壁上。</p>

	<p>當在牆壁、天花板上進行切割或者鑽孔時，請注意不要損壞電綫以及其他隱藏的設備。</p>
	<p>本產品僅供家庭日常使用，請不要用于商業用途或在其它特殊環境中使用（例如：室外）；也不能用來排出有危險的或者容易爆炸的物質或者氣體。如您在特殊環境中使用本產品，方太將不承擔責任。</p>
	<p>吸油煙機和燃氣竈同時使用時，請保證房間內良好的空氣流通（不適用於內循環油煙機）。</p>
	<p>油鍋着火時，請立即關閉吸油煙機（吸油煙機的運行會助燃火勢）。采用有效的滅火方法滅火。例如，用金屬的蓋子將明火蓋住，立即關閉燃氣總閥門，并使易燃物遠離明火。</p>
	<p>出風管必須確保排到室外。為了避免火災的發生并保持空氣清新，請將廢氣排到室外。請不要將廢氣排到牆內、閣樓、車庫中。（只適用於有出風管的吸油煙機）</p>
	<p>吸油煙機使用環境的溫度不能超過40°C。</p>
	<p>請按照本說明書規定的方法清洗油煙機，否則吸油煙機有起火的危險。</p>
	<p>當油杯內的儲油達到油杯容積的三分之二時，請及時清理，防止溢出。油杯中所收集的廢油請勿食用！</p>
	<p>在移動吸油煙機進行安裝、清潔或者修理前，務必切斷電源，以免觸電；在進行安裝、清潔或修理時，應佩戴防護手套，以防被吸油煙機內金屬板快口傷手。</p>
	<p>安裝完成后，插頭應在能夠到的位置。吸油煙機若長期不用，請切斷電源。</p>
	<p>如果電源綫損壞，請聯系授權服務提供商或合格技術人員進行更換，以避免危險。</p>

	<p>出現異常現象時，關閉吸油煙機電源開關，拔下電源插頭或者切斷總電源，馬上致電方太授權的服務中心。異常狀態下連續運轉易發生觸電、火災等危險。</p>
	<p>請不要讓兒童自己單獨使用，或放到嬰兒能夠接觸到的地方，否則有可能導致燒傷、觸電或者其他意外傷害。</p>
	<p>請勿讓兒童玩耍塑料薄膜和包裝箱，這可能會產生窒息事故，所以請讓包裝材料遠離兒童，包裝材料不是玩具。孩童應嚴格監管以確保他們不會玩耍產品。</p>

禁止

	<p>如果不按本說明書規定的方法清洗油煙機，吸油煙機有起火的風險。</p>
	<p>請不要對電源綫進行改制、拉伸、結扣以及施加重物、擠壓等，否則易導致電源綫破損而發生觸電和火災等事故。</p>
	<p>禁止私自改動吸油煙機內部布綫，否則有可能會發生異常動作導致人體受傷。不當修理可能發生觸電、火災等危險。</p>
	<p>吸油煙機排出的廢氣不能排放到用于排出燃燒燃氣或其他燃料的煙霧使用的熱煙道中。必須遵守相關空氣排放的規定。</p>
	<p>禁止在沒有鍋具的情況下使用燃氣竈，否則會損害上方的吸油煙機。禁止在吸油煙機底下直接使用明火。</p>
	<p>請勿觸摸已經開啓或者剛關閉不久的燈泡，以免燙傷。</p>
	<p>吸油煙機運行時不要將手或其他物品伸入葉輪中以免造成傷害。</p>
	<p>嚴禁電機、開關、接插件等電氣部件沾水；禁止用水衝洗吸油煙機。吸油煙機被水淋濕后，請不要使用；如果使用會導致漏電、觸電等事故。</p>
	<p>請不要用潮濕的手觸摸電源插頭、電器部件以及操作電源開關，否則易發生觸電事故。</p>

- a. 保修服務須由方太公司授權的服務機構或人員執行。如私自拆機維修，產品將不享受保修。
- b. 為避免任何可能對產品的損害，請確保實際電壓和頻率與本說明書中闡明的一致。
- c. 當吸油煙機與使用非電能的設備同時使用時，室內負壓不得超過4Pa (4 x 10⁻⁵ bar) (針對德國市場)。
- d. 其他燃燒器具產生的燃燒氣體可能由于回流會對安全產生不利影響，這些氣體可能導致一氧化碳中毒，因此在安裝吸油煙機后，應由專業人員測試煙管，以確保燃燒氣體不會回流。
- e. 本公司產品上使用了鋼化玻璃，玻璃的鋼化機理決定這種玻璃存在極小概率的自爆。一旦發生非使用不當的自爆，我公司承諾免費提供該配件。鋼化玻璃在以下情況，發生破裂的幾率可能會大大提高，請避免發生：例如用炊具或其他硬物敲擊玻璃，特別是敲擊玻璃四個角部；打開油煙機周圍櫥櫃門時撞擊到玻璃；玻璃處于過冷和過熱、冷熱交替嚴重的環境等情況。

使用方法

主要技術參數

電參數

型號	電壓/頻率	整機功率	電機功率	LED燈功率
EMG9035	220~240V/50Hz	260W	258W	2W

外排性能參數

型號	EMG9035	產品尺寸	長895mm×寬512mm×高582mm	
	檔位	自動巡航檔	強檔	弱檔
220V/50Hz	風量(m ³ /h)	1030	900	700
	噪聲(dB(A))	54	48	42
	最大靜壓值(Pa)	880	870	500
240V/50Hz	風量(m ³ /h)	1030	900	700
	噪聲(dB(A))	55	48	42
	最大靜壓值(Pa)	1050	910	490

- a. 本產品為智慧產品，當排風阻力大于產品設定阻力時，220V/50Hz工況下自動巡航增壓模式的最大風量可至1420m³/h，240V/50Hz工況下自動巡航增壓模式的最大風量可至1440m³/h。
- a. 所示噪聲值為聲壓級噪聲，對應聲功率級噪聲為聲壓級噪聲加14分貝。
- b. 風量測試按照IEC 61591-2010標準。噪聲測試按照IEC 60704-3-2006標準。

操作說明

■ 讓我們熟悉吸油煙機控制界面

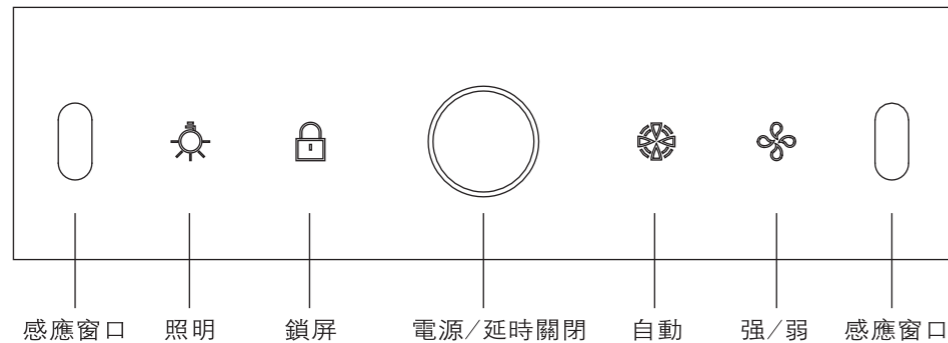

1. ○ 電源

- 按一次○，○常亮，吸油煙機開啓，2分鐘內無其他按鍵操作，吸油煙機自動關閉。
- 風機開啓狀態下，按一次○，○閃爍，進入延時狀態，2分鐘後吸油煙機自動關閉。
- 延時狀態下，按○/⏸，延時狀態保持不變。
- 延時狀態下，按⏸/⏸，則退出延時進入對應功能狀態。
- 延時狀態下，按一次○，吸油煙機關閉。
- 延時或待機狀態下，長按5秒○，關閉所有功能（包含手勢感應功能），吸油煙機進入關機狀態，再按一次○，手勢感應功能自動恢復。

以下所有命令都在待機狀態下進行

2. ⏸ 自動檔

按一次⏸，⏸常亮，吸油煙機進入自動巡航增壓模式運行（該模式下可自動檢測煙道阻力，並根據煙道阻力大小調整吸油煙機運行狀態）。再按一次⏸，風機關閉。

3. ⏸ 強/弱檔

- 按一次⏸，⏸常亮，吸油煙機進入強檔運行。
- 強檔狀態下，按一次⏸，⏸亮度減弱，吸油煙機進入弱檔運行。
- 弱檔狀態下，按一次⏸，風機關閉。

4. ⏸ 照明

按一次⏸，⏸常亮，照明燈打開，再按關閉。

5. ⏸ 鎖屏

- 長按1.5秒⏸，⏸常亮，吸油煙機進入鎖屏狀態，此時操作其他任何按鍵（包括手勢感應功能），⏸閃爍並發出蜂鳴聲，提示按鍵無效。
- 鎖屏狀態下，長按1.5秒⏸，鎖屏解除，所有按鍵可正常操作。

6. 手勢感應功能

- 揮手👋快速經過兩端感應窗口，開啓/關閉吸油煙機（包括風機&照明燈）。
- 吸油煙機關閉狀態下，同時按下⏸鍵和⏸鍵5s，開啓/關閉手勢感應功能。

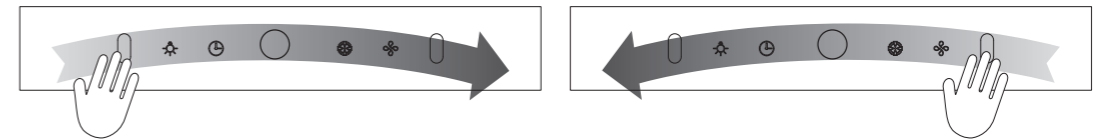

手勢感應功能示意圖

清洗保養

- ⚠警告：**
- 如果不按說明書規定的方法清洗，吸油煙機有起火的危險。
 - 當清潔、維修吸油煙機前，務必先拔掉電源綫插頭，以免觸電。
 - 清潔時應防止電機、各控制鍵等電氣部件進水。
 - 當風機在使用時，禁止將手放入風機運轉區域。
 - 切勿使用汽油、酸性物質、苯、溶劑或任何其他化學藥劑清洗吸油煙機。

爲了更加舒適的使用，請經常對吸油煙機表面、蝶翼板、進風口罩及油杯進行清潔。經常清潔吸油煙機表面、蝶翼板、進風口罩及油杯將有利于吸油煙機的正常使用的。

■ 清潔吸油煙機表面

- ⚠警告：**請不要使用清潔球、刷子、百潔布以及粗布等粗糙物進行清潔，以免劃傷機體表面。
1. 只用中性皂或者中性洗滌劑進行清潔，清潔後用柔軟的布擦乾機體表面。
 2. 如果吸油煙機表面看上去有污點，使用中性的清潔劑清潔污點，並避免清潔劑接觸各控制鍵。把清潔劑滴至污點之處並短暫停留（清潔劑不要在機體上停留過長，那樣將造成損害），使用柔軟的抹布將污點擦去；用微濕的毛巾將清潔劑除去，然後再用柔軟的干毛巾將機體擦乾。
 3. 不要讓污漬在吸油煙機表面停留時間過長。
 4. 如不小心將含鹽的溶液、消毒劑、漂白粉以及其他清潔劑沾到不銹鋼面板（這些溶劑中大部分含有有害的化學成分），應立即用濕布擦拭，然後用干布擦乾。

■ 清洗油杯及蝶翼板

1. 用雙手托住油杯兩端，保持油杯水平，向吸油煙機前方慢慢移出，取下油杯，倒去積油（圖1）；
2. 首先，雙手抓住蝶翼板前沿，向下翻轉，使蝶翼板卡扣脫離，同時再向下翻轉一定角度，取下蝶翼板（圖2），將油杯、蝶翼板放入加有中性洗滌劑的溫水中浸泡，用軟刷將其清洗干淨；
3. 清潔完畢擦乾後，裝上蝶翼板、油杯。

- ★ 建議：每次使用吸油煙機後，請擦拭吸油煙機外表面一次（包括蝶翼板外表面）；每三個月清洗蝶翼板一次。

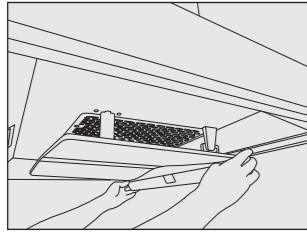

(圖1)

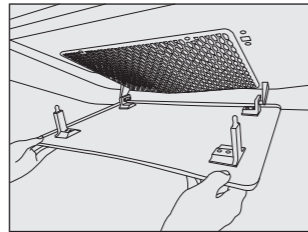

(圖2)

■ 更換LED燈

1. 左手扶住LED燈，右手用小型一字螺絲刀插入LED燈邊緣（圖3），輕微用力下撬，取下LED燈，打開接線口（圖4）；
2. 更換整個LED燈；
3. 雙手將LED燈扣進燈孔位置。

⚠ 警告：更換LED燈必須由專業售後服務人員進行，更換之前請務必拔掉電源插頭。

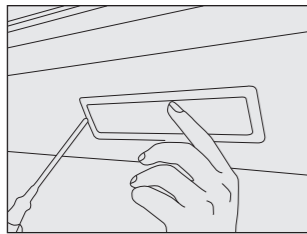

(圖3)

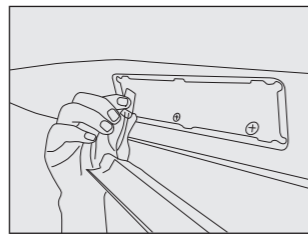

(圖4)

常見故障的識別和處理

故障現象	可能原因	檢修方法
按開關，吸油煙機不工作，LED燈不亮	未接通電源	檢查電源插頭是否插好
		檢查插座是否有240V交流電
電機轉動但LED燈不亮	LED燈損壞	由售後服務人員更換LED燈
有機械振動噪聲	螺釘鬆動	檢查吸油煙機表面螺釘是否擰緊
吸力不強	吸油煙機與竈面的安裝距離太大	降低吸油煙機安裝高度 (本項必須由專業人員進行)
	吸油煙機周圍環境門窗通風太多，對流太大	關閉部分門窗
	出風管長期未清洗	更換出風管
	止逆閥粘住(未完全打開)	清洗出風罩或更換出風罩
噪聲太大	出風管表面凹陷變形	重新安裝出風管



- a. 更換LED燈，請聯系方太授權的服務中心。
- b. 上述故障排除后，吸油煙機仍不能正常工作，請聯系方太授權的服務中心。
- c. 保修期內保修需提供以下信息：
 1. 購買日期
 2. 產品型號
 3. 序列號
 4. 購買相關憑證
- d. 其他人員不得擅自維修吸油煙機，以免造成嚴重后果，而且產品將不享受保修服務。
- e. 以下情況不提供保修服務：
 1. 用戶搬運、安裝、使用、維護、保管不當而損壞的。
 2. 超出正常使用條件，強行使用本產品造成的故障和損傷（例如電壓超出264V或低於189.2V而損壞的）。
 3. 自行或非方太指定服務人員或服務機構安裝和拆修的產品。
 4. 購買憑證和保修卡信息與產品不符的。
 5. 因不可抗力造成產品損壞的（如自然災害、戰爭等）。
 6. 不根據“使用說明書”的規定使用，造成產品故障或損傷的。

安裝

籠煙範圍

油煙機左右籠煙範圍

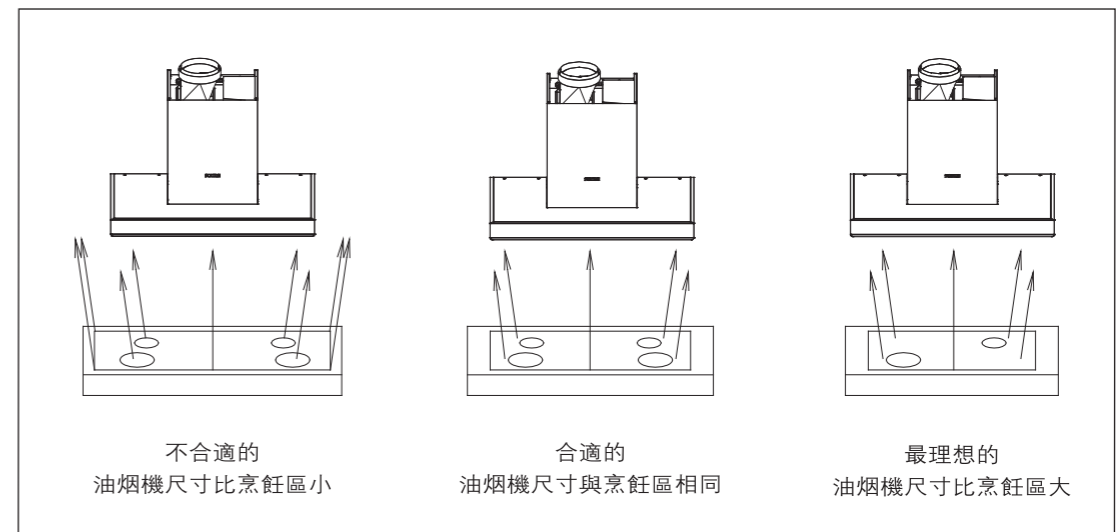

油煙機前后籠煙範圍

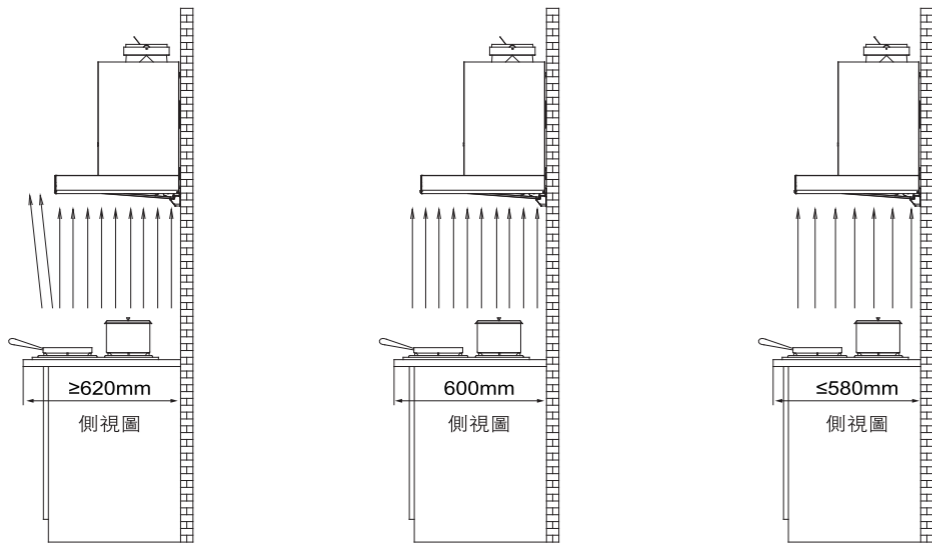

不適宜的
油煙機尺寸比烹飪區小

合適的
油煙機尺寸與烹飪區相同

最理想的
油煙機尺寸比烹飪區大

裝箱單

	主機	1		蝶翼板組件	1
	出風管	1		出風罩	1
	鋁箔膠帶	1		上密封墊	1
	裝飾罩	1		掛鈎	1
	裝飾罩掛鈎	1		油杯	1
	產品使用說明書	1		十字槽自攻鎖緊螺釘ST3.9x9.5	4

	膨脹管φ10X60	6		木螺釘M4.5x60	6
	十字槽盤頭自攻鎖緊螺釘M4x18	8		十字槽盤頭自攻螺釘ST2.9x19	4
	十字槽大扁頭自攻鎖緊螺釘M4x6	2			

安裝警告

■ 安全注意事項

★特別說明：為保障安全和正確使用，本產品(包括出風管及其他零部件)必須由本公司指派的專業人員進行安裝和維修。如因消費者委托非本公司指派的人員或消費者自行安裝和維修，而導致產品不能正常使用的，即使在保修期內，也不屬於免費維修範圍。

在安裝以前，請仔細閱讀所有的說明。特別請注意以下事項：

1. 如果您正在對您的廚房進行裝修，請勿將吸油煙機暴露在外。因為建築材料、灰塵、油漆、塗料以及它們所揮發的氣體，會使吸油煙機表面產生腐蝕以及失去光澤。建議在廚房裝修完畢以后再安裝吸油煙機。
2. 由于本吸油煙機的安裝程序比較複雜，且重量較重，應由專業安裝維修人員按照說明書進行安裝。
3. 在清潔吸油煙機周圍物品(如吊頂、櫥櫃)有可能會觸及吸油煙機時，請戴上防護手套及做好其他防護措施，以防磕傷或劃傷。
4. 在牆壁上鑽孔時，請注意不要損壞電線以及其他隱藏的設備。安裝時不能接通電源；應在主電源箱中關閉電源。
5. 吸油煙機應使用專用電源插座，並且，專用電源插座應有可靠接地。因電源線中途連接、使用延長綫以及多口配綫器時易發生觸電、插頭插座發熱以及火災。請確保由專業的電工來操作，並且要嚴格按照所有適用的國家和地方的電力法規；在接綫以前，請先關閉電源并采取合理措施防止電源自動接通。
6. 如果在安裝吸油煙機前，需要移動燃氣竈，則在移動燃氣竈之前，請先關閉燃氣總閥門。
7. 安裝吸油煙機牆壁要有足夠的強度。
8. 為確保安全和安裝順利，請使用隨機附件進行安裝，安裝膨脹管時，膨脹管與牆孔的配合一定要緊密，嚴禁鑽孔過大，以免膨脹管鬆動，造成意外跌落！
9. 為了避免火災的發生，請將廢氣排到室外。
10. 請不要將廢氣排到牆內、閣樓、車庫中。
11. 吸油煙機排出的廢氣不能排放到用于排出燃燒燃氣或其他燃料的煙霧使用的熱煙道中。
12. 安裝時須盡量保證機身左右水平。
13. 安裝完畢，經試運轉無異常現象后確認合格。請用戶注意仔細閱讀、妥善保存本說明書。



牆面安裝

安裝吸油煙機的牆壁要有足夠的支撐強度，對於中空牆壁，中空板實心層的厚度必須大於30mm以上，對於混凝土牆壁可直接打安裝孔。整機必須牢固安裝在牆壁上。

產品尺寸圖

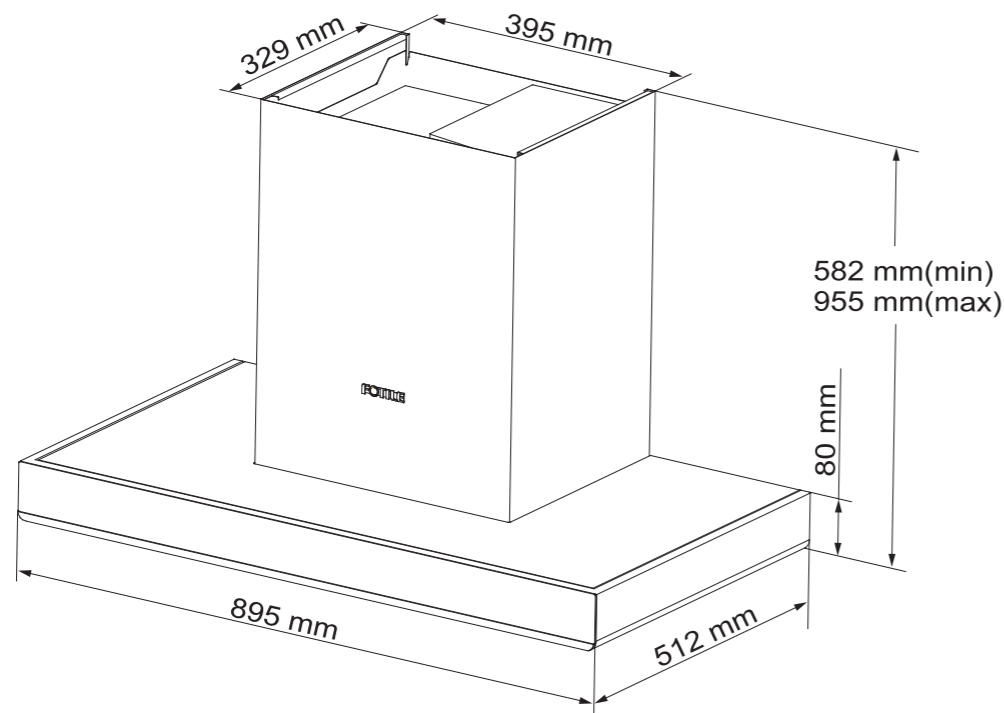

產品基本尺寸

安裝建議

■ 安裝位置

該吸油煙機只能安裝於家庭廚房；請勿在其他場合使用該吸油煙機。
吸油煙機必須安裝在爐竈的上方，吸油煙機必須保持水平。
吸油煙機周圍環境的溫度不能超過40°C。
安裝牆面應為不可燃物，嚴禁安裝在木質等易燃的牆面上。

■ 吸油煙機與櫥櫃安裝示意圖（單位：mm）

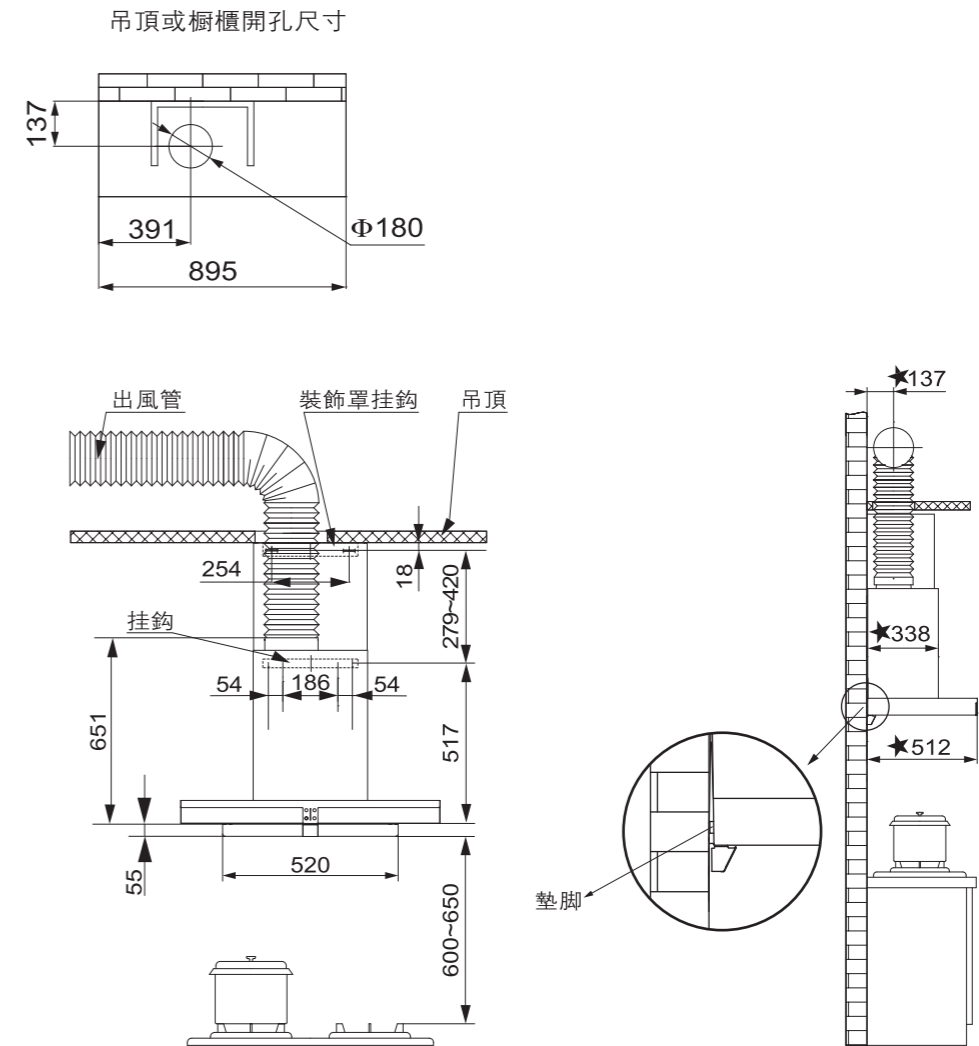

安裝示意圖
(★表示到牆的距離)



吸油煙機的安裝高度為推薦值，圖示櫥櫃與吸油煙機搭配示意僅供參考，當本產品的安裝高度（即爐竈上烹飪器具的支承面與吸油煙機最低部位的距離）低於600mm時，低於600mm部分的所有部件均為吸油煙機的不易燃部件或工作在安全特低電壓下的部件，且這些部件變形時，不會影響對觸及帶電部件的防護。（如所屬地區有相關法律規定油煙機安裝高度，建議遵守相關法律，但產品的吸油煙效果可能會受到一定影響。）

■ 安裝前的準備工作

- 1.警告：為了不對吸油煙機造成損害，請確保不要讓雜物等進入排風口。
 估算吸油煙機通到室外的出風管的位置，參見安裝示意圖。
 一個直綫的、較短的出風管將使得吸油煙機的排煙更加順暢。
 出風管與牆孔的連接處使用管道膠帶嚴格進行密封。必須確保出風管與出風罩連接牢固。
 牆洞過小會影響排煙效果，在保證安全的前提下，建議擴孔至出風管尺寸。

2.工具準備：

安裝本吸油煙機應具備以下工具（包括並不限於以下工具）：

- | | | |
|------------------|-----------|---------|
| (1) 衝擊電鑽（帶鑽頭Φ10） | (2) 十字螺絲刀 | (3) 鋼絲鉗 |
| (4) 卷尺 | (5) 榔頭 | (6) 水平尺 |

安裝步驟

1. 將衝擊電鑽配Φ10mm鑽頭備用；
2. 如安裝示意圖所示，在堅實的牆壁上準確確定衝擊鑽鑽孔的位置，鑽孔並牢固埋設膨脹管，固定掛鉤和裝飾罩掛鉤，旋入木螺釘擰緊；裝飾罩掛鉤前端可用2顆ST2.9×19的自攻螺釘加強固定到吊頂上（如圖1和圖2所示）；
3. 如圖3所示，用8顆M4×18螺釘將出風罩及密封圈固定在主機頂部上；
4. 用2顆ST3.9×9.5自攻螺釘將出風管固定在出風罩上，用鋁箔膠帶纏繞密封（如圖3所示）；
5. 牢掛主機，正視——不歪不斜，側視——機體貼牆面，與牆壁間略有縫隙；
6. 按（安裝示意圖）安裝出風管，檢查管壁不鼓不癢，彎角自如，出風管與牆壁間密封嚴密以防倒煙，止逆閥片啓落無阻；
7. 按（圖4）示意，用M4×6短螺釘把風機架與掛鉤連接固定；
8. 風機外罩、裝飾罩安裝（如圖5所示）：
 - (1) 將裝飾罩放入風機外罩內；
 - (2) 把風機外罩、裝飾罩同時拿起，先把裝飾罩卡入裝飾罩掛鉤內，然後同時將裝飾罩、風機外罩沿裝飾罩掛鉤組件推到底；
 - (3) 把裝飾罩、風機外罩推到底後，風機外罩緩緩滑下來，將風機外罩卡扣卡入風機架，然後將風機外罩插入頂板與風機架的間隙內。
9. 安裝蝶翼板：
 - (1) 雙手緊握蝶翼板前側，把蝶翼板後側的左右掛鉤，放入集煙罩的左右掛鉤架內；
 - (2) 雙手托住蝶翼板，使其往上旋轉，蝶翼板旋轉同時往裏推，最後使蝶翼板上的碰爪剛好插入集煙罩上的碰扣內。
10. 將主機電源插頭插入電源插座；
11. 裝上油杯組件（如圖6所示）。



- a. 安裝前先取下風機外罩；
- b. 若與櫥櫃配合安裝，步驟4與步驟5互換；
- c. 根據鑽孔地方的具體情況選定鑽頭。

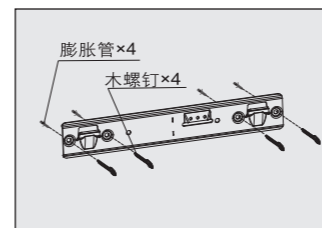

(Fig.1)

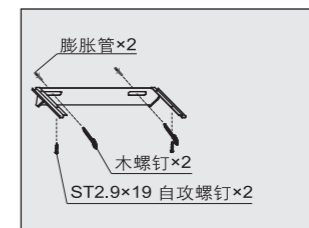

(Fig.2)

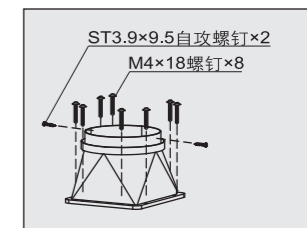

(Fig.3)

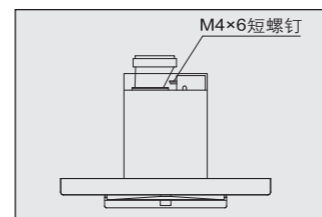

(Fig.4)

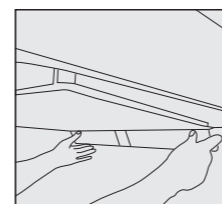

(Fig.6)

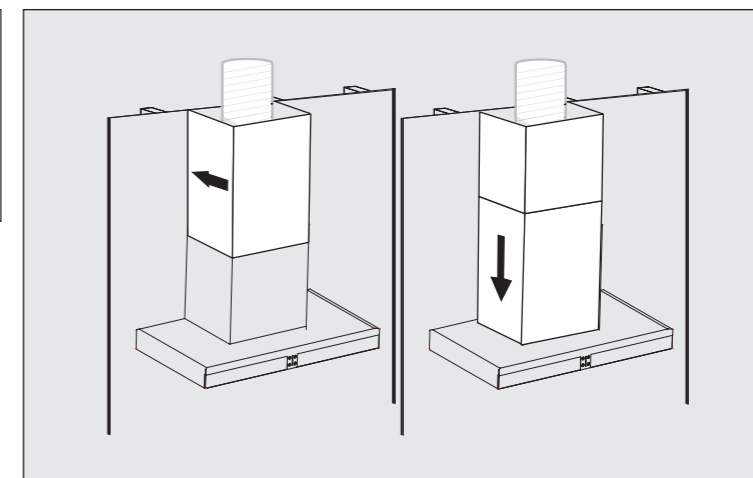

(Fig.5)

安裝後的調試

1. 按下開關鍵，再按燈鍵，檢查照明燈是否正常；
2. 按下強/弱檔鍵或自動檔鍵，檢查電機轉動是否正常，如出現下列異常情況，應立即切斷電源，停止運轉，並檢查是否為安裝緣故（若確定吸油煙機發生故障，請致電方太授權的服務中心）
 - (1) 機體震動劇烈
 - (2) 膨脹管鬆動
 - (3) 葉輪不轉動
 - (4) 葉輪轉動時明顯的摩擦聲
 - (5) 電機出現異常聲響
3. 按兩次開關鍵，風機停止轉動。
 - (1) 如果電源軟線損壞，為了避免危險，必須由製造商、其維修部或類似部門的專業人員更換；
 - (2) 當吸油煙機與燃燒燃氣或其他燃料的爐灶同時使用時，房間必須通風良好。

正確處理本產品



此標記表示本產品不應與其他家庭垃圾一起處理。為防止不合理的廢品處理可能會對環境或人類健康造成危害，需要對本產品合理回收利用，以促進材料、資源的可持續利用發展。如您需要退回使用過的機器，請使用回收採集系統或聯系相關零售商，他們會把機器環保、安全的回收利用。

爆炸圖

