

FOTILE

USER'S HANDBOOK

IMPORTANT SAFETY INSTRUCTIONS
READ CAREFULLY AND KEEP FOR
FUTURE REFERENC

MICROWAVE OVEN

HW25800K-01AG
HW25800K-03G/03BG
HW25800K-C2G



Thank you for choosing our products please read the handbook carefully before use and keep it for future reference.

CONTENTS

Warning and Safety Instructions	1
Important safety instructions	1
Precautions	1
Applicable Utensils	2
Avoid Fire Explosion and Scalding	4
Packing List	5
Specification and Structure of Microwave Oven	6
Installation	7
Precautions	7
Installation Steps	8
Operation Instruction	8
Navigation	8
Initial Use	9
Microwave and Grill	9
Defrost Function	9
Control Panel	10
Cleaning and Maintenance	18
Cooking Tips	19
Cooking by Microwave	19
Method of Defrosting Foods	20
Normal Phenomena and Trouble Shooting	21
Precautions	21
Normal Phenomena	21
Trouble Shooting	21

This manual contains the information updated till the time when it is printed. We keen on technical innovation, we will reserve the rights to improve or modify the product and user's manual without any prior notices. Some of the illustrations in this manual are for reference purpose only and subject to the actual products if there are any differences.

Warning and Safety Instructions

● Important safety instructions

- **WARNING:** Accessible parts may become hot when grill is in use. Children should be kept away.
- **WARNING:** Ensure that the appliance is switched off before replacing the lamp to avoid the possibility of electric shock. If the supply cord is damaged, it must be replaced by the manufacturer, its service agent or similar qualified persons in order to avoid a hazard.
- **WARNING:** If the door or door seals are damaged, the oven must not be operated until it has been repaired by a competent person;
- **WARNING:** It is hazardous for anyone other than a competent person to carry out any service or repair operation that involves the removal of a cover which gives protection against exposure to microwave energy and high voltage;
- **WARNING:** Liquids and other foods must not be heated in sealed containers since they are liable to explode;
- **WARNING:** Only allow children to use the oven without supervision when adequate instructions have been given so that child is able to use the oven in a safe way and understands the hazards of improper use;
- The appliance is not intended for use by persons (including children) with reducing physical sensory or mental capabilities, or lack of experience and knowledge, unless they have been given supervision or instruction concerning use of the appliance by a person responsible for their safety.
- Children should be supervised to ensure that they do not play with the appliance.
- Do not dispose of electrical appliances as unsorted municipal waste, use separate collection facilities.
- Contact your local government for information regarding the collection systems available.
- If electrical appliances are disposed of in landfills or dumps, hazardous substances can leak into the groundwater and get into the food chain, damaging your health and well-being.
- When replacing old appliances with new ones, the retailer is legally obligated to take back your old appliance for disposing at least free of charge.







● Precautions



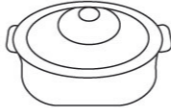

1. Please read this user's manual carefully before initial use.
2. This appliance is for residential use only to cook, defrost, reheat and to grill food. Any other usage is not supported by the manufacturer and could be dangerous. The manufacturer cannot be held liable for damage caused by improper or incorrect use of the appliance.
3. The appliance is not intended for using by children or the disabled person unless they are supervised or properly instructed.
4. Make sure that the actual voltage and frequency are accorded with the ones clarified in this User's Manual to avoid any possible damages to the oven and be sure the unit is safe grounded.
5. Make sure that your oven is connected to a standard power socket with safe grounding to avoid electric shock.
6. Place the oven horizontally in a place of well ventilation and without the risk of corruption. It should stay away from high temperature and steam.
7. Place the oven as far as possible from TV set, radio and antenna to avoid any interference. A minimum distance of 5 meters is recommended.

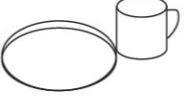
8. Installation and repairs may only be carried out by a suitably qualified and competent person in accordance with national and local safety regulations. Repairs and other work by unqualified persons could be dangerous. The manufacturer cannot be held liable for unauthorized work.
9. Never open the casing of the appliance. Tampering with electrical connections or components and mechanical parts is highly dangerous and can cause operational faults or electric shock.
10. Do not block the ventilation hole of the oven to ensure well ventilation.
11. Do not have the oven working without putting any food inside, which may damage the appliance. After using, put a full glass of water on the glass tray in order to avoid any damage to the appliance.
12. Before serving, remember to allow a sufficient standing time and then always check the temperature of the actual food itself after taking it out of the microwave. The temperature of the container is not an indication of the temperature of the food or liquid in it.
13. Never put regular mercury or liquid thermometer into the oven for heating and measuring, since it's liable to sparkle or do damage to the appliance. Interrupt the cooking process before check food temperature.
14. Do not use the microwave if
 - the door is warped.
 - the door hinges are loose.
 - holes or cracks are visible in the casing, the door or the oven interior walls.
 Operating the appliance with this type of damage will result in microwave leakage and present a hazard to the user.
15. Please do as follows to keep the glass tray from damage:
 - Do not wash the tray with water until it's cool.
 - Do not put red-hot food or utensils on cool tray.
 - Do not cold food or utensils on red-hot tray.
 - Do not put anything exceeding 5Kg on the tray.
 - Do not use the oven for food storage purpose.
 - Only use accessories which are authorized by FOTILE.

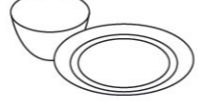
● **Applicable Utensils**

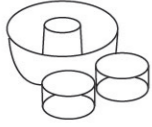
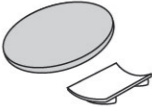
- ★ Only use utensils that are suitable for using in microwave ovens:
- ★ How to check whether the utensils are suitable for microwave oven.
 - Tips  Put the utensil into microwave oven along with a glass of 300ml cold water, and choose MICROWAVE mode to cook for 1 minute. It is the applicable utensil if it keeps cool while water gets hot. On the contrary, it cannot be used in microwave oven if the utensil gets hot, that means it has absorbed a certain content of microwaves. This method is inapplicable for plastic utensils.
- ★ Improper utensils used in microwave oven would not only bring bad taste to the food, but also do damage to the oven or the utensil. Please take the following table for reference.

Type of Utensil	Microwave	Grill	Grill Combi
 Heat-resistant Glass Vessels	Applicable ⚠ When cooking jams, please use super heat-resistant glass vessels that can endure sudden cold or hot	Inapplicable	Inapplicable
 Non-heat-resistant Glass Vessels	Inapplicable ⚠ Including cut-glass and tempered glass	Inapplicable	Inapplicable
 Heat-resistant Plastic Vessels	Applicable ⚠ Please use the vessels marked "For Microwave Oven Use". ⚠ Pay attention to those plastic covers which are not heat-resistant. ⚠ Avoid using covers with good air-tightness ⚠ Never cook food containing high content of oil or sugar, which creates abundant heat.	Inapplicable ⚠ Plastics for grill purpose is applicable.	Inapplicable
 Non-heat-resistant Plastic Vessels	Inapplicable ⚠ Never use any materials that can be deteriorated by microwave, such as polythene, melamine, hydroxybenzene and carbamide resin, etc. ⚠ Foam tray is applicable only for defrosting fresh food	Inapplicable	Inapplicable
 Lacquer wares	Inapplicable ⚠ The painting may fall off or rupture.	Inapplicable	Inapplicable
 Ceramic Vessels	Applicable ⚠ Vessels with paintings or gold/silver decorations is not applicable since it tends to cause scratches and sparkles.	Applicable ⚠ Never use ceramics with painting inside, which will fall off.	Applicable

Type of Utensil	Microwave	Grill	Grill Combi
 Vessels Made of Metals (such as Aluminum)	Inapplicable ⚠ Never use metal meshwork or metal bunches which may cause sparkles. ⚠ Even the metal painting plate for microwave oven use is not applicable.	Applicable ⚠ Do not use the vessel with resin handle. Inapplicable	Inapplicable
 Vessels Made of Wood, Bamboo and Paper	Inapplicable ⚠ These kind of vessels are flammable.	Inapplicable ⚠ Paper vessels made by heat-resistant processing are applicable.	Inapplicable
 Grill Rack	Inapplicable	Applicable	Applicable
 Cling Film for Microwave Purpose	Applicable ⚠ Foods containing high content of oil are not applicable.	Inapplicable ⚠ It will melt in high temperature.	Inapplicable
 Aluminum Foil	Inapplicable ⚠ It's available if making use of the reflective character of microwave to defrost fresh foods.	Applicable ⚠ Pack foods in aluminum foil to grill.	Inapplicable

● Avoid Fire, Explosion and Scalding

1. In order to avoid the inside of oven catches fire, please do as follows:
 - a. Never sealed the foods before cooking.
 - b. Before cooking the food which packed by paper or plastic bag, please take the binding away.
 - c. When heating food in plastic or paper containers, keep an eye on the oven due to the possibility of ignition;
 - d. When cooking foods with one-off utensils, please pay attention to the status inside oven.
 - e. Never cook alcohol, oil or fried foods, for it is not easy to control the temperature of oil.
 - f. When cooking small quantity of food, care enough to avoid the hazard of fire due to overheating.
 - g. Each time after cooking, use a piece of wet cloth and dry cloth one after another to wipe off the offscourings or oil on the mica or walls of the oven, in order to avoid any black smoke or fire.
 - h. When the cooking utensil catches fire, switch off the appliance immediately. Effective extinguishing measures must be taken at once, such as keep the door closed.

- i. Exercise caution when cooking or reheating food with a high sugar content. If heated for too long, the sugar may caramelize or ignite.
 - j. To avoid fuelling and flames, do not open the oven door if smoke occurs in the oven interior. Interrupt the process, turn off the oven and remove the plug. Do not open the door until the smoke has dispersed.
 - k. The contents of feeding bottles and baby food jars shall be stirred or shaken and the temperature checked before consumption, in order to avoid burning;
2. In order to avoid explosion, please do as follows:
 - a. Never cook foods with sealed vessels, such as nursing-bottle with lid or nipple.
 - b. When cooking liquid, please use a broad rim vessel, and reserve enough space in the vessel for boiling.
 - c. Microwave heating of beverages can result in delayed eruptive boiling, therefore care must be taken when handling the container;
 - d. Before cooking any round or columniform food such as potatoes, chestnuts or sausages, please use knife or fork to perforate in order to avoid explosion.
 - e. Do not take the cooked eggs or liquid out of oven immediately to avoid delaying spurting. In order to avoid explosion, never cook fresh or cooked eggs with eggshell.
 - f. Do not take the poached egg or rice glue ball out of oven immediately to avoid explosion. Wait a moment after opening the door.
 3. In order to avoid scalding of sudden boiling, please do as follows.
 - a. Take cooked food out of oven with gloves instead of bare hands to avoid scalding by steam.
 - b. When quartz tube is red-hot or the food is just done, do not touch the upper board of the cavity. Thus cooking food in GRILL mode, use gloves only to overturn the food since the temperature inside is very high.
 - c. In order to avoid scalding the content of nursing-bottles or baby food cans shall be stirred or shaken and the temperature shall be checked before consumption.

Packing List

1. Take the packing material out of oven, and examine carefully whether the oven is intact.
 - a. Is the oven impacted or pressed by heavy object?
 - b. Is the oven door flat and switch unhindered?
 - c. Is the metal meshwork on door curved or deformed?
 - d. Is the power cord damaged or loose?

If you find any one of the above happens, please contact FOTILE authorized service people.

2. Packing list

Name	Quantity
Microwave Oven	1
User's Manual	1
Cruciform Slot Round Weeden Screws M4 x 24 black zinc galvanized	4
Grill Rack	1
Glass Tray	1
Turntables Shaft	1

Specification and Structure of Microwave Oven

Model	HW25800K-01AG	HW25800K-03G/03BG	HW25800K-C2G
Rated Voltage	220-240V 50Hz	120V 60Hz/220V 60Hz	220-240V 50Hz
	220V 60Hz	220-240V 50Hz	220V 60Hz/120V 60Hz
Rated Input Power	1150W-1350W(Microwave) 750W-850W (Grill)		
Rated Output Power(Microwave)	800W		
Rated Frequency(Microwave)	2450MHz		
External Dimension(L x W x H)	595mm x 385mm x 368mm		595mmx385mmx 416mm
	Oven Capacity		
Accessory for Heating Only	Special Glass Tray		
Net Weight	20kg	22kg	20kg

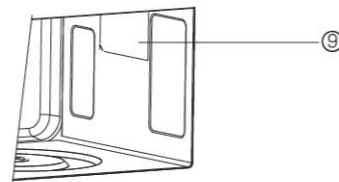
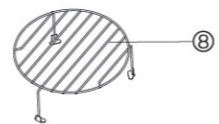
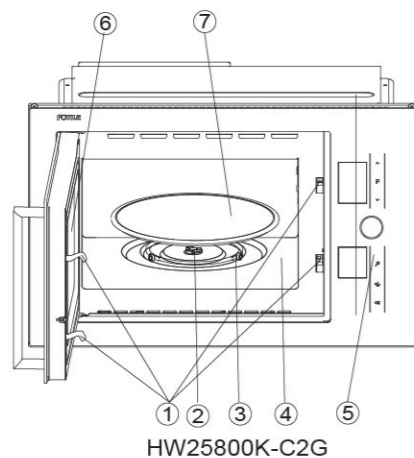
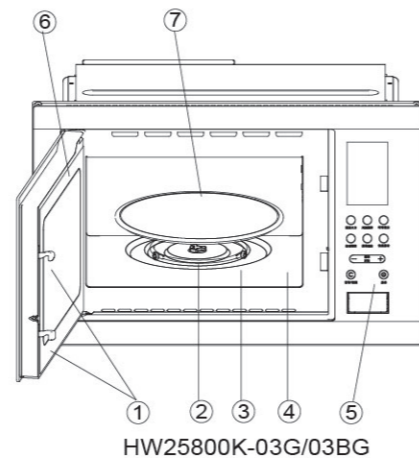
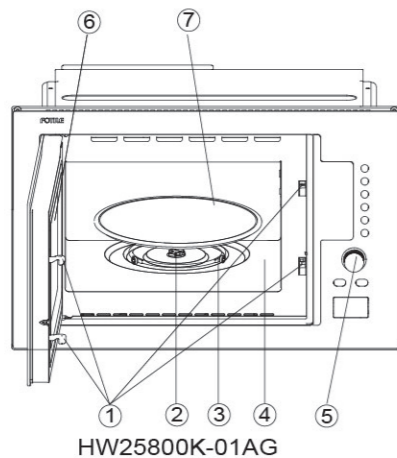

● Illustration

- ① Safety interlock system: To ensure the oven does not work unless the door is closed.
- ② Turnable shaft: To make the glass tray turning.
- ③ Turnable ring assembly: support the glass turntable and rotate along its path.
- ④ Oven cavity.
- ⑤ Control panel: Please refer to the description for control panel.
- ⑥ Observation window: To watch the food inside through a metal shielding meshwork.
- ⑦ Glass tray: The vessel containing food is put on the tray, which turns to get the food heated uniformly.
- ⑧ Grill rack: Only use for grill or combined modes.
- ⑨ Mica: To avoid vapor or grease entering into the tube the mica must not be removed, which could effect the operation of microwave.

Installation

● Precautions

Microwave oven must be installed one the 3 cupboards as demonstrated below (ground cupboard, wall cupboard, and high cupboard), which has ventilation channels. If the user does not install the oven in these 3 types of cupboards, FOTILE is not responsible for any accident caused.

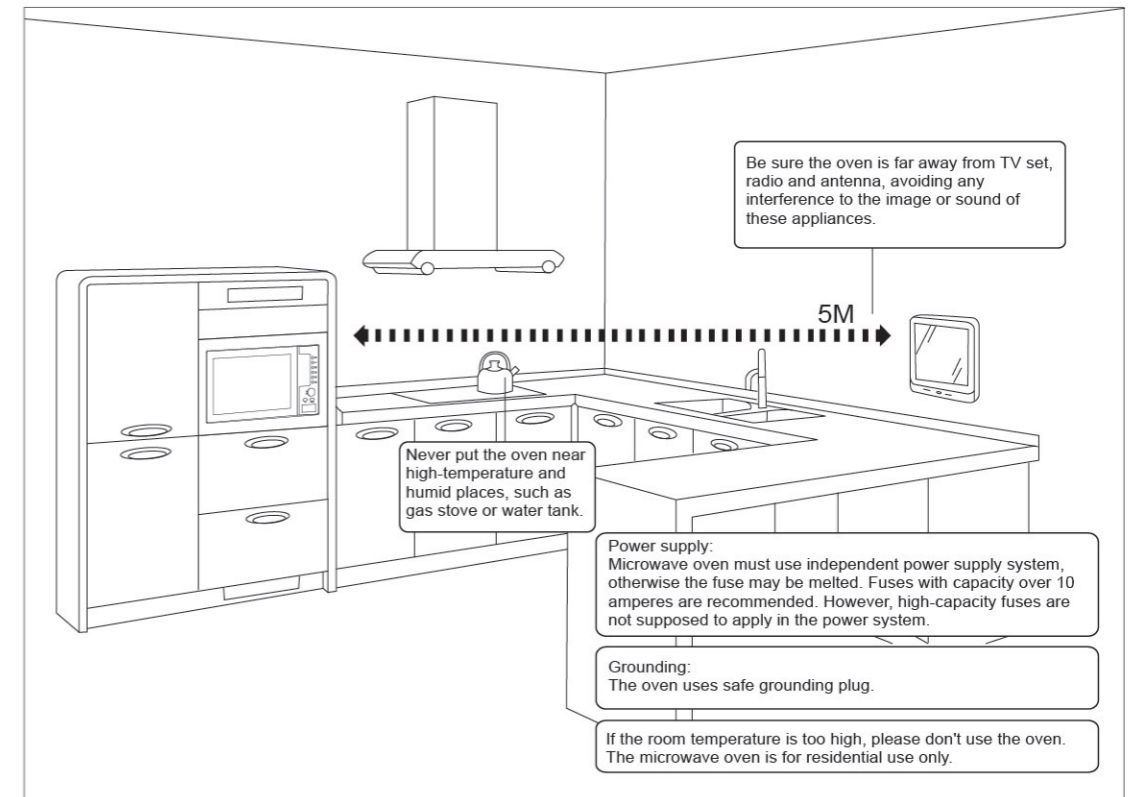

● Installation Steps

Exhaust hole (available)

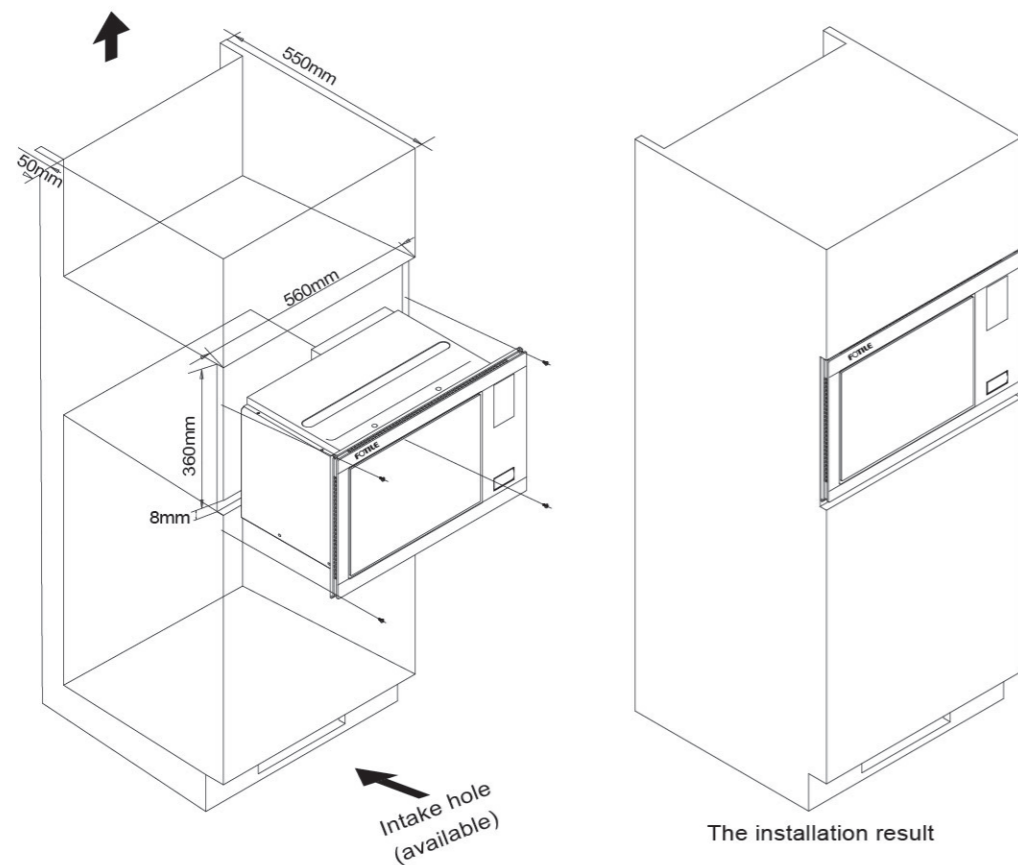

1. Push the microwave oven into the cabinet.
2. The distance for the microwave oven frame and the cabinet is 8mm.
3. Fixing the microwave oven in the cabinet by the four screws which type are ST4 x 25.

4. Set cooking time.
5. The microwave oven starts cooking with set program. The program will pause if the microwave oven door is opened, on the contrary the microwave oven will resume operation after "Start" button is pressed.
6. It's definitely suggested to wear glove to take or turn over food. Do not touch the walls of the cavity.
7. In combination mode or grill mode, do not touch the top, the door, and both sides of the oven because they are very hot. Only the control panel can be touched.
8. When food is cooked, the buzzer beeps for 3 times before the oven stops working, and the indication light is off.

● Initial Use

When using microwave oven for the first time, you may catch bad smell and even see white smoke from the oven. It's a normal phenomenon, and after using it for several times, it will not happen again. Be sure that the door and window open in your room to keep good ventilation. Anyway, you can take the following steps to avoid this phenomenon:

1. Before initial use choosing GRILL mode to dry cook for several times.



Dry cook is only available in GRILL mode. Not for MICROWAVE mode or a combination mode.

2. Before initial use choosing MICROWAVE mode and putting a glass of water on the glass tray to cook in high power for several times.

● Microwave and Grill

1. Microwave is penetrable. It can penetrate into the food and cook the food in a short time without losing water of the food. However, it cannot turn the surface of food brown and the food crispy.
2. The energy of grill function comes from radiation of the heating tube, which can make the surface of food brown. But if the food is too thick, it could be possible that the inside of food remains uncooked while its surface is charred.
Therefore, the combination of microwave and grill can take both advantages to make the food look good and taste good.



Do not use microwave when the oven is empty-loaded. And never use metal utensils that may cause spark or potential risks.

Operation Instruction

★ Operation Instruction for HW25800K-03G/03BG/01AG

● Navigation

1. Plug in the power supply.
2. Put food onto the glass tray, and close the oven door. Be careful that never switch on the appliance without food inside, in order to avoid damage to the oven.
3. Choose cooking mode.
 - a. The grill rack must be taken out if "Microwave" function is chosen.
 - b. Make sure that the distance between food and heating tube must be 5cm at least if combination function is chosen. The food must be turned over during operation.

● Defrost Function

It's one of the characteristics of microwave oven to defrost food. Microwave defrosts is quicker than electric ovens and safer than defrosting at room temperature, since no harmful bacteria will breed in microwave. Turn the function knob to choose defrost function, and then turn the timer knob to set defrost time according to the weight of food. As microwave can not penetrate 4cm from one side, you have to turn over the food from time to time if it's large and thick. It's suggested to take out the defrosted part and make the rest of food easier to defrost; otherwise it's possible that the surface of food gets defrosted, while its inside is still frozen.

1. It's very necessary to turn over the food during defrosting in order to ensure the food defrosted averagely.

2. Defrosting is done when the food can be cut off by knife.
3. Defrosting take longer time than normal cooking.
4. The defrosted food should be consumed as soon as possible. Do not put it into refrigerator again.

● Control Panel

1. Switch on the appliance. The LED flashes for 3 times to display all functions, then ":" flashes. Choose time or cooking functions.

2. Clock Setting (24 hours).

When ":" displays, press "preset clock" key, and operate the "Timer /Weight/Auto Menu" knob/key to confirm hour. Press "preset clock" key, and operate the "Timer /Weight/Auto Menu" knob/key to confirm minute. Finally, press "preset clock" key to confirm the above steps. Clock setting is completed, and current time is displayed. To reset or change the time, please repeat the above steps.

3. Power Setting.

Press "Microwave" button each time, "100P", "80P", "60P", "40P", "20P" will display in turn. Operate the "Timer /Weight/Auto Menu" knob/key to set time, and press " Start " to start cooking with set power.

100P  : 100% microwave (high power). Boiling water, cooking fresh fruit, vegetables and candied fruit.

80P  : 80% microwave (high-medium power). Cooking fish, seafood, meat, poultry, eggs and cakes.

60P  : 60% microwave (medium power). Cooking cakes, boiling food, melting butter and chocolate.

40P  : 40% microwave (medium-low power). Cooking cuts of meat, stewing soup, softening butter.

20P  : 20% microwave (low power). Keeping warm, softening ice cream.

4. Quick Start.

Press "Express" each time, and LED displays "0:30", "1:00", and "1:30" sequentially.

0:30: Default time is 30 seconds.

1:00: Default time is 1 minute.

1:30: Default time is 1 minute and 30 seconds.

Press " Start " to start cooking with high power in chosen time.

5. Light Wave Grill

Press " Grill " key, and then operate the "Timer /Weight/Auto Menu" knob/key to set time. Press "Start" to cook in chosen time. "Light Wave Grill" function is for the purpose of cooking sliced meat such as beefsteak, pork steak, barbecue, sausage and chicken wings. It is also applicable for cooking sandwich and making food crispy.

6. Microwave + Grill (Combination)

Press "Grill combi" key each time, and LED displays "Grill combi1", "Grill combi2" and "Grill combi3" sequentially.

Grill combi1: 30% cooking time in microwave, and 70% cooking time in grill, best for grill, recommended for western-style food such as beefsteak.

Grill combi2: 55% cooking time in microwave, and 45% cooking time in grill, relatively quicker in cooking, recommended for a whole piece of poultry such as chicken, duck and goose.

Grill combi3: 70% cooking time in microwave, and 30% cooking time in grill, quickest in cooking, recommended for a whole piece of poultry such as chicken, duck and goose.

When the combination function is chosen, operate the "Timer /Weight/Auto Menu" knob/key to set time. Press "Start" to cook in chosen time.



In combination mode, all heating elements including grill rack and cooking utensils are very hot. Be careful when taking foods out of oven you can use thick cloth or special gloves for microwave oven purpose in order to avoid scalding.

Pre-heating is unnecessary in "Grill" mode.

7. Auto Defrost

Press "Auto Defrost", and LED displays "Defrost Meat", "Defrost Poultry" and "Defrost Seafood" sequentially.

Defrost Meat: for defrosting meat, with weight ranging from 0.1Kg to 2.0Kg.

Defrost Poultry: for defrosting poultry, with weight ranging from 0.2Kg to 3.0Kg (for HW25800K-01AG) 0.1Kg to 2.0Kg (for HW25800K-03G/03BG).

Defrost Seafood: for defrosting seafood, with weight ranging from 0.1Kg to 0.9Kg.

When the defrost function is chosen, operate the "Timer /Weight/Auto Menu" knob/key to set the weight. Press "Start" when the program detects that the food needs to be turned over, the buzzer sounds twice a second to remind you.

8. Pause/Cancel

Press "Pause/Cancel", the operation of setting power, cooking time or defrost time can be canceled. When the oven is working, "Pause/Cancel" one time or open the oven door, the oven will pause; press the button twice, the program is cancelled.

9. Adjust the Auto Menu by rotating the coder leftward.

A.1 Rice: for cooking rice with weight ranging from 0.15Kg to 0.6Kg (for HW25800K-01AG) 0.1Kg to 0.5Kg (for HW25800K-03G/03BG);

A.2 Fresh Vegetable: for cooking vegetables with weight ranging from 0.1Kg to 0.5Kg (for HW25800K-01AG) 0.15Kg to 0.6Kg (for HW25800K-03G/03BG);

A.3 Popcorn: for making popcorn with corn weight ranging from 0.07Kg to 0.13Kg (for HW25800K-01AG) 0.1Kg (for HW25800K-03G/03BG);

A.4 Potato: for cooking 1,2 or 3 of potato (each weighing about 0.3Kg) (for HW25800K-01AG). Or with weight ranging from 0.15Kg to 0.6Kg (for HW25800K-03G/03BG);

A.5 Pizza: for heating pizza with a proximate weight ranging from 300g to 500g (for HW25800K-01AG) 150g to 300g (for HW25800K-03G/03BG);

A.6 Beverage: for heating 1 to 3 cup of liquid, (each capacity about 230ml) (for HW25800K-01AG), Or a cup of liquid weight 250g, 500g and 700g (for HW25800K-03G/03BG);

A.7 Fish: for cooking fish with weight ranging from 0.2Kg to 0.6Kg (for HW25800K-01AG) 0.1Kg to 0.5Kg (for HW25800K-03G/03BG) (this function will pause at the first half of working time, reminding user to turn over the fish);

A.8 Chicken: for grilling chicken with weight ranging from 0.8Kg to 1.4Kg(for HW25800K-01AG) 0.2Kg to 1.2Kg (for HW25800K-03G/03BG) (this function will pause at the first half of working time, reminding user to turn over the fish).



1. As the above programs are designed for foods within the temperature range 20°C-25°C, doneness of food is subject to the actual temperature. Please adjust time by yourself.
2. It's suggested to use cling film to cover food when cooking potatoes or fish, in order to avoid evaporation of water.
3. The taste is determined by the shape, weight and temperature of the food. When using "Auto Menu" function, please follow the above instructions, and make adjustment by yourself if the food is not well done.
4. Auto Menu
Doneness of food in "Auto Menu" function is determined by personal favor, size, quantity and placement of food and the working voltage. If the food is not well done, please adjust cooking time according to actual conditions.

10. Combination Cooking Program

Combination: For each time (or each phase), the maximum time to be set is 30 minutes(HW25800W-01AG) 60 minutes(for HW25800K-03G/03BG). Users can operate in 4 phases. For example, If you want to set 10 minutes of maximum microwave power plus 10 minutes of grill, you should follow this sequence: press "Microwave" button, the LED displays 100P; then turn "Timer /Weight/Auto Menu" knob to set the time as "10:00"; press "Grill" and turn "Timer /Weight/Auto Menu" knob; when the LED displays "10:00", press "Start" and the appliance will start cooking according to the program set. It will execute the first phase of program, until time decrease to "0"; then the second phase of program goes on until it ends.



Combination cooking program can not be set in "Auto Menu" mode.

11. Delay Time Function

When regular program and cooking time is set, the LED displays time, "8:28" for example, press "Preset clock" key button for 3 seconds, it's in delay time state now. When the defrost function is chosen, operate the "Timer /Weight/Auto Menu" knob/key to put into hour, and then press "Preset clock" key, and When the defrost function is chosen, operate the "Timer /Weight/Auto Menu" knob/key to set minute. Finally, press "Preset clock" key or waiting for 5 seconds later to start this function. The LED will display current time.

When checking delayed time, press "Clock Setting" button, and the LED will display delayed time. Release the button, the LED resumes current time.

When "Delay Time" function is activated:

- a. Press "Start" if you want to start cooking immediately.
- b. Press "Pause/Cancel" button if you want to cancel this function.

12. Reminder Tone

- a. The buzzer beeps for each valid operation. And low buzzer beeps for invalid operation.
- b. When each program ends, the buzzer will reminder for 3 times, and the LED displays "END". If the "Pause/Cancel" button is not pressed or the oven door not opened, the buzzer will beep every 3 minutes for reminding. When the door is opened, the LED will display ":" or current time.
- c. When the oven is cooking something, press "Microwave" button, and current cooking power will be displayed on LED. Release the button, the LED will display the residual time of cooking. Operation of the oven is not affected.

13. Child Lock Function

When LED displays " : " or current time, keep pressing "Pause/Cancel" button for 3 seconds. Child lock function is activated when the buzzer beeps and the LED " 🔒 " displays. The appliance can not be operated in this state. In order to unlock the oven, keep pressing "Pause/Cancel" button for 3 seconds, the buzzer beeps and the " 🔒 " disappears from LED.



1. In the process of setting functions, if no program is input for 2 minutes, it will display ":" or current time.
2. The "Start" button is activated in one of the following two conditions:
 - a. The oven door is closed in 2 minutes;
 - b. The "Pause/Cancel" button is press within 2 minutes, otherwise it's locked.

14. Fan Delay Function:

After the microwave oven stops working, the fan will continue to work for 2 minutes.

REMARK: this method can greatly reduce the rising of temperature of inner electric elements, by which to reach the target of prolong the lifespan of microwave oven. Also the temperature in the kitchen cabinet and be much safer.

15. The Door Control:

When the door is opened the light will be off. If the microwave oven is in the state of working, if the work stops it means the key of is pressed for once. After the door is opened, press the key of "OK" to restart.



1. After the cooking, the display screen shows: "End" and the buzzer beeps once every 3 minutes. To press any key to go back to the standby model
2. The key " ^ " or " v " , when setting time or weight, the intermittent press or non-stop press are both allowed.

★ Operation Instruction for HW2500K-C2G

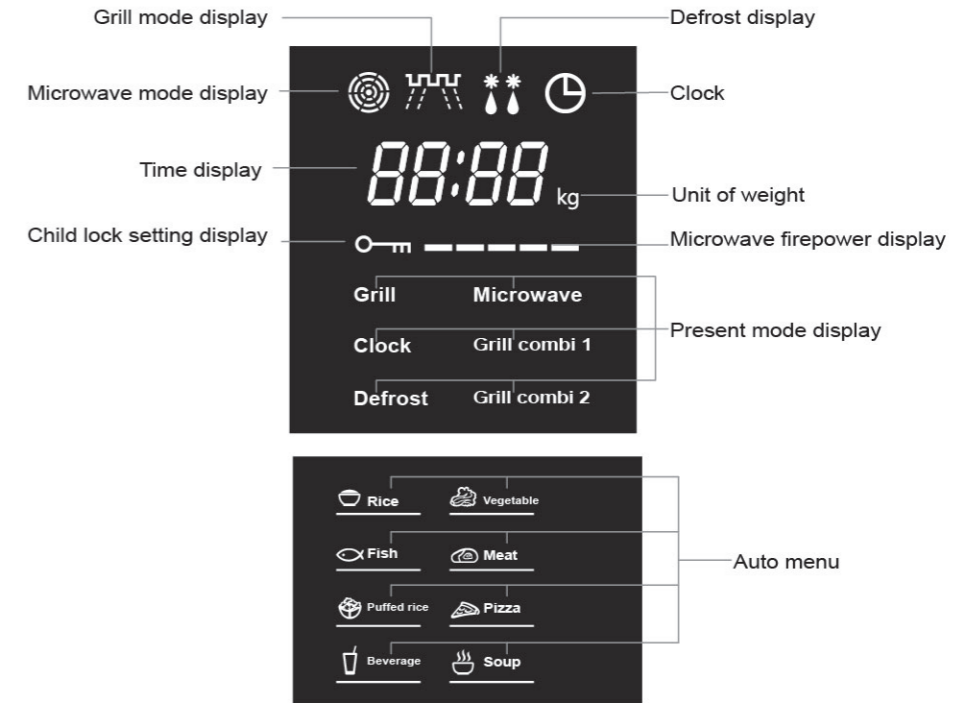
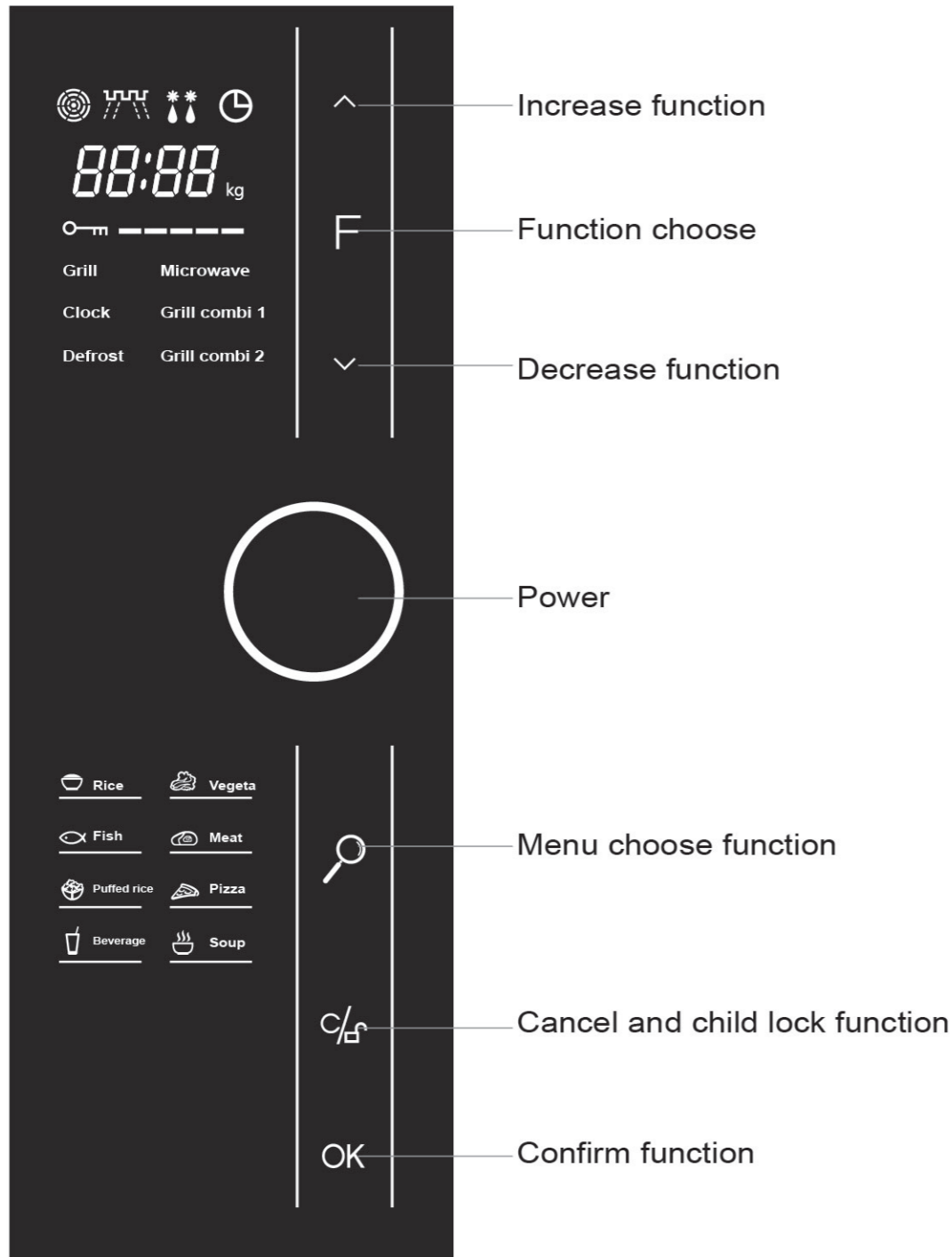

● Power on

When power is on, the display screen is totally illuminated and after one second the buzzer beeps for one time, and then the display screen goes out.

To touch the power key and the display screen shows “🕒” the present time is 0:00, the clock begins to time and it goes into standby mode.

At any mode once touching the power key for once, the power is off.

At the model of power off, when touching the other keys except power key they will be invalid, and when touching one time it will go back to standby mode.

REMARK: at standby mode the display screen shows only present time and the “🕒” icon.

1. The setting of microwave oven cooking

- Function choosing: at standby mode when touching the “F” key, the display screen will show “🕒” (flashes), “P100” (flashes), “----” and the other basic function key to let illuminated.
- Firepower setting: the microwave firepower can be controlled by key of “^” or “v”. The microwave power cycling is P100 ⇒ P80 ⇒ P60 ⇒ P40 ⇒ P20. When the corresponding microwave power is set, touch the key “OK” to confirm, and the time begins from 0:10.
- Time setting: microwave working time can be set by the key “^” or “v”, and press key “OK” to confirm then the microwave starts working.

2. The setting of grilling cooking:

- Function choosing: at standby mode when touching the “F” key, the display screen will show “🕒” (flashes), “Grill” (flashes) and the other basic function key to let illuminated.
- Time setting: microwave working time can be set by the key “^” or “v”, and press key “OK” to confirm then the grilling cooking starts working.

3. The setting of baking and grilling combination cooking:

- Function choosing: at standby mode when touching the “F” key, the display screen will show “🕒” (flashes), “Co-1” (flashes), “baking and grilling combination” and the other basic function key to let illuminated.

B. Time setting: microwave working time can be set by the key “ ^ ” or “ v ” , and press key “ OK ” to confirm then the baking and grilling combination starts working.
 (The operation procedures of combination 2 are the same as above, to touch the “F” key, the display screen will show “baking and grilling combination 2” and the time will be set.)
 The baking and grilling combination 1: are suitable for cooking of flesh, a whole chicken or duck, food like this.
 The baking and grilling combination 2: are suitable for cooking of cuisine occidental, grilled fillet steak and so on.

4. The setting of defrosting:

- A. Function choosing: at standby mode when touching the “F” key, the display screen will show “  ” (flashes), “0.10” “kg”, “Defrost” and the other basic function key to let illuminated.
 B. Weight setting: the defrost weight can be set by the key “ ^ ” or “ v ” , “0.10 ⇌ 0.20 ⇌ 0.30 …… 1.70 ⇌ 1.80” , and press key “ ^ ” or “ v ” to confirm then the defrost starts working.

5. The setting of clock function(24 hours system)

- A. Function choosing: at standby mode when touching the “F” key, the display screen will show “  ” (flashes), “Hour”(flashes) “Clock” (flashes), and the other basic function key to let illuminated.
 B. Hour setting: press the key “ ^ ” or “ v ” to adjust the “Hour” into the time needed to be set, and press key “ok” to confirm. The display shows (flashes) “minute” (flashes), “clock” (flashes), and then the other basic function key to let illuminated.
 C. Minute setting: press the key “ ^ ” or “ v ” to adjust the “Hour” into the time needed to be set, and press key “ ok ” to confirm. Clock setting being finished, goes back to mode of standby.

F.E:

The present time is “0:00” , and the time needed to be set is “12:30” .

Touch “ F ” key for six times, and the display screen shows (flashes), “clock” (flashes) Press key “ ^ ” or “ v ” to adjust the “hour” to “12” , and press “OK” to confirm. “12:00” (“:00” flashes) and the others do not change. Then press key “ ^ ” or “ v ” to adjust the “minute” to “30” , and press “ OK ” to confirm, the display screen shows: “12:30” and “  ” , the setting of clock is finished.

6. The setting menu cooking:

- A. Function choosing: At standby mode, touching the “  ” key to choose the menu.
 B. Weight setting: press the key “ ^ ” or “ v ” to set the different weight for menu. Press key “OK”
 (1). Rice: suit to cooking rice with weight from 0.15kg to 0.60kg;
 (2). Vegetable: suit to cooking vegetable with weight from 0.10kg to 0.50kg;
 (3). Meat: suit to cooking meat with weight from 0.20kg to 0.60kg(to turn over the food when the buzzer beeps);
 (4). Pizza: suit to heat pizza with weight about 0.30kg/0.50;
 (5). Beverage: suit to heat beverage or liquid with capacity of 230ml for 1-3 cups.
 (6). Puffed rice: suit to puff corn with weight from 0.07kg to 0.13kg;
 (7). Fish: suit to steam the fish with weight from 0.20kg to 0.60kg;

F.E: to cook rice of 0.30kg.



At the model of standby, to press the key “  ” , and the display shows "0.15kg", "kg", "rice"(flashes), and the other basic Function key to let illuminated.



Press the key “ ^ ” or “ v ” to set the weight of rice, and the weight set is 0.30kg. After the confirmation to the weight, Press key “OK” to confirm, the cooking of rice begins.(the setting of the other menu are similar with rice)



- As the above programs are designed for foods within the temperature range 20°C-25°C, doneness of food is subject to the actual temperature. Please adjust time by yourself.
- It is suggested to use special microwave vessel when cooking rice, in order to avoid evaporation of water or rice.
- it's suggested to use cling film to cover food when cooking potatoes or fish, in order to avoid evaporation of water.
- The taste is determined by the shape, weight and temperature of the food. When using "Auto Menu" function, please follow the above instructions, and make adjustment by yourself if the food is not well done.
- Auto Menu
 Doneness of food in "Auto Menu" function is determined by personal favor, size, quantity and placement of food and the working voltage. If the food is not well done, please adjust cooking time according to actual conditions.

7. The setting of child locks function:

Lock: at the mode of standby, to touch the key of “  ” for 3 seconds. The display will shows: present clock “  ” “o-m” , and then the child lock is set successfully. At this moment all the keys are invalid except “  ” and “power” .

Unlock: at the mode of standby, to touch the key of “  ” for 3 seconds. The display will shows: present clock “  ” and then the child lock is set successfully.

8. The setting of multi section function:

When the multi section function is set, microwave, grilling, the baking and grilling combination 1 and baking and grilling combination 2 set can be set at multi section. It is forbidden to set P100. microwave, or grilling, or the baking and grilling combination 1 and baking and grilling Combination 2 at the same time. Multi section can be set as three sections at most.

F.E: to heat in different firepower when making soup.

- To set the first section: to set microwave P100 firepower for 6 minutes according to the microwave setting methods.(Don't press key "OK")
- To set the second section: to set microwave P40 firepower for 5 minutes according to the microwave setting methods.(Don't press key "OK")
- To set the third section: to set microwave P20 firepower for 4 minutes according to the microwave setting methods. Then press the key "OK" to start working.



REMARK: this function are used to the cooking the food need the adjustment of firepower like making soup, porridge, etc.

9. The setting of quick start:

At the mode of standby, to touch the key “ ^ ” or “ v ” , the time will increase for 30 seconds by one touch, the maximum time will be 10 minutes. After the setting of time, press the key of "OK" to confirm, and the microwave starts working. The Acquiescent firepower will be P100.

10. The function of cancel and pause:

When setting the function to press the key “  ” for once, the present function setting is cancelled and it goes back to standby mode.

After start working, to press the key “  ” for once, it will pause. Touching key "OK" to restart, or to touch the “  ” again to go back to standby mode directly.

11. Auto return function:

When setting functions, it will go back to standby mode when there is no any effective key operation.

12. Inquiry function:

When the machine is working, to touch the key "F" for once, and the display shows "⌚" the time on present clock, it will go back to working interface.

13. Fan delay function:

After the microwave oven stops working, the fan will continue to work for 2 minutes.

REMARK: this method can greatly reduce the rising of temperature of inner electric elements, by which to reach the target of prolong the lifespan of microwave oven. Also the temperature in the kitchen cabinet and be much safer.

14. The door control:

When the door is opened the light will be off. If the microwave oven is in the state of working, if the work stops it means the key of "⏸" is pressed for once. After the door is opened, press the key of "OK" to restart.



1. After the cooking, the display screen shows: "End" and the buzzer beeps once every 3 minutes. To press any key to go back to the standby model
2. The key "∧" or "∨", when setting time or weight, the intermittent press or non-stop press are both allowed.

Cleaning and Maintenance

Unplug this appliance before cleaning.

- ★ The oven should be cleaned regularly, Do not use a steam-cleaner to clean this appliance. Pressurized steam could reach the electrical components and cause a short circuit. If the food or liquids containing salt splash the cavity interior, wipe these away thoroughly to avoid corrosion on the cavity surface.
- ★ Failure to maintain the oven in a clean condition could lead to deterioration of the surface that could adversely affect the life of the appliance and possibly result in a hazardous situation;
- ★ Surface of Microwave Oven
 - Clean the surface with a wet cloth containing neutral detergent. Do not use any corrosive detergent or damaging tools.
- ★ Oven Door
 - Clean the doorframe, window, seal and adjacent parts with warm and wet cloth. Do not use any corrosive detergent.
- ★ Control Panel
 - Be careful when cleaning the control panel. Use a soft cloth with certain amount of water to clean it (if the panel gets wet, use a dry soft cloth instead). Do not scrape the panel or clean it with corrosive detergent.
- ★ Grill Rack
 - After using, clean the rack with neutral detergent.
- ★ Oven Cavity
 - Clean the cavity and the cover of wave-guide tube with wet warm cloth. Wipe off the food residue, which may cause partial overheating inside oven. Do not use harsh abrasive cleaners or sharp metal scrapers to clean the oven door glass since they can scratch the surface, which may result in shattering of the glass. Clean the turnable ring and glass tray with neutral detergent and dry them before putting back into oven.



Peculiar smell may exist in the oven after long-term usage. You can get rid of the smell by one of the following ways:

1. Put several slices of fresh lemon or spoons of lemon juice in a glass, and cook it in oven for 2-3 minutes with high microwave power.
2. Put a glass of black tea into oven, and cook it for 2-3 minutes with high microwave power.
3. Put some orange pericarp inside the oven, and cook for 1 minute with high power.

Cooking Tips

● Cooking by Microwave

- ★ Placement of food
 - Put the thick part outward, and the thin part inward (in the middle).
- ★ Setting Cooking Time
 - Set a short cooking time first to see whether the food is cooked well. If not, set longer time to continue cooking. If a long time is set at the beginning the food might be burnt.
- ★ Covering of Food
 - Cover the food with cling film, lid or napkin that are applicable for microwave. This could prevent splash of liquid and make the food cooked averagely.
- ★ Partial Wrapping of Food
 - Partial wrapping can keep the thin part of food from being overcooked. Wrap these parts with aluminum foil for defrosting.
- ★ Stirring of Food
 - If necessary, stir the food for one or two times during cooking.
- ★ Turning of Food
 - When cooking foods such as chicken leg, hamburger or steaks, turn the food over when it's half done in order to make it cooked averagely.
- ★ Re-placement of Food
 - The position of food shall be changed during cooking, in order to make the food averagely cooked. For example, exchange the positions between the outward part and inward part, or between the upper part and lower part.
- ★ Keeping of Food
 - When the food is cooked, keep it in the oven for a while, better with some coverings. If possible, take the food out of oven and stir it.
- ★ Checking Doneness
 - Doneness of food can be judged by the color and hardness of food. For example, observe whether there's vapor rising from the whole piece instead of part or edge of food, or whether the joint of poultry is easy to tear apart, or whether there's any fresh blood on meat or poultry, or whether the fish is transparent and easy to cut off by knife and fork.
- ★ Concentration of Vapor
 - It's a normal phenomenon that vapor concentrates during microwave cooking when the water inside food is vaporized. Generally speaking, food with coverings concentrates less vapor than that without coverings. Therefore, good ventilation shall be kept inside the oven.

- ★ Frying Pan for Microwave Purpose
 - Before using frying pan or other utensils, segregate the pan from ceramic bottom with a heat-resistant ware such as ceramic plate, in order to avoid crack of ceramic bottom due to overheating. The frying pan shall not work too long time in the oven.
- ★ Preservative Paper for Microwave Purpose
 - When cooking grease food, make sure that the preservative paper is not in contact with food since the paper is very likely to melt.
- ★ Plastic Cookware for Microwave Purpose
 - Some plastic cookware for microwave purpose can not be used to cook food containing too much oil or sugar.
- ★ Plastic Cookware for Microwave Purpose
 - Some plastic cookware for microwave purpose can not be used to cook food containing too much oil or sugar.

● Method of Defrosting Foods

- ★ Steak
 - Wrap the slim end of the steaks with aluminum foil.
 - Lay the steakes on a pan with the thinnest part in the middle. Make sure that the steaks are chopped apart entirely.
 - Turn over the steaks when they are half done, and wrap up the defrosted part with aluminum foil.
 - Put the steaks back on pan, and close oven door to resume defrosting.
 - When defrosting is done, keep the steaks in aluminum foil for 5-15 minutes.
- ★ Beef (Chopped Meat)
 - Wrap the edge of beef with aluminum foil, and put it on a pan.
 - Turn over the beef when they are half done. Take out the defrosted part, and wrap the beef again.
 - Close oven door to resume defrosting.
 - When defrosting is done, keep the beef in aluminum foil for 5-15 minutes.
- ★ Roasted Meat (Beef/Pork/Lamb)
 - Wrap the edge of meat ith aluminum foil.
 - Put it on a pan.
 - Turn over the meat when it's half done, and wrap the defrosted part.
 - Close oven door to resume defrosting.
 - When defrosting is done, keep the meat in aluminum foil for 10-30 minutes.
- ★ Poultry
 - Remove commercial packing of the poultry, and wrap the wings and feet with aluminum foil.
 - Put it on a pan with its chest downward.
 - Turn over the poultry when it's half done, and wrap the defrosted part.
 - Close oven door to resume defrosting.
 - When defrosting is done, keep the poultry in aluminum foil for 10-30 minutes.
- ★ Chicken Chips (Wings and Legs)
 - Wrap the bare bones with aluminum foil.
 - Put the chips on a pan.
 - Turn over the chips when it's half done, and wrap the defrosted part.
 - Close oven door to resume defrosting.
 - When defrosting is done, keep the chips in aluminum foil for 5-30 minutes.

Normal Phenomena and Trouble Shooting

● Precautions



Be careful of microwave radiation.

There's microwave radiation and high voltage inside the oven. In order to reduce the risk of hazard to human being, do not disassemble this appliance by yourself except for qualified service people and never expose yourself in the radiation from microwave generator or transmitter.

1. If the oven door or seal is damaged, do not use the oven anymore until it's fixed by qualified service people.
2. If the socket and fuse are not in good condition, please contact FOTILE's after-sales service center or qualified service people.
3. Except for qualified service people, do not allow anyone to make any inspection on the oven, including disassembling the cover.

● Normal Phenomena

1. Radio and TV reception may be interfered when microwave oven operating. It's similar to the interference of small electrical appliances, like mixer, vacuum cleaner, and electric fan. It's normal.
2. Although the microwave oven will not be damaged when operating empty loaded for a short time, the user should try best to avoid this from happening.
3. The microwave oven must be cleaned regularly, especially when microwave or grill functions are applied, because the oil stain accumulating at the top of cavity and walls may cause smoke.
4. The temperature inside cavity will rise if the magnetron operates for a long time. In order to protect the magnetron, the oven will shut off automatically and resume operation shortly afterwards. It's normal.

● Trouble Shooting

Trouble	Possible Cause	Solution
No display on LED	Power cord not plugged in tightly.	Unplug, then plug again after 10 seconds.
	Fuse blowing or circuit breaker works.	Contact FOTILE authorized service people.
	Trouble with socket.	Test socket with other appliances.
	In standby mode.	Press any button to end standby.
Microwave oven can not be started.	Door not closed well.	Close door well.
	Pressing "Start/OK" button not pressed yet.	Press "Start" button.
	Other programs are chosen.	Press Pause / Cancele" button to cancel chosen program and choose a new program.
	Mistake in choosing programs	Choose correct program based on the manual.
	Mistake in pressing " Pause / Cancele" button.	Choose correct cooking program.